

Flanders
State of
the Art

LARGE SCALE RESEARCH INFRASTRUCTURES IN FLANDERS

FLEMISH PARTICIPATION IN INTERNATIONAL
RESEARCH INFRASTRUCTURES
2020

Flemish Government

Department of Economy, Science and Innovation
Koning Albert II-laan 35, box 10, B-1030 BRUSSELS

Published by

Johan Hanssens, Secretary General, Department EWI

Editors

Michele Oleo, Policy Advisor, Department EWI
Caroline Volckaert, Science Policy Advisor
research infrastructures, FWO-Flanders

Publication Date

February 2020

D/2020/3241/021

Content

This guide was realised in cooperation with FWO, Research Foundation Flanders. A special thanks goes to each research infrastructure for their contribution.

The content is finalised on 31 of January 2020 and gives a status “as is” of the infrastructure.

Cover image

© Unsplash by Joshua Coleman



LARGE SCALE RESEARCH INFRASTRUCTURES IN FLANDERS

FLEMISH PARTICIPATION IN INTERNATIONAL
RESEARCH INFRASTRUCTURES

2020

Editorial

Today, the challenges are numerous: climate change, sustainable energy, our health, etc. Complex issues that require thorough and solid answers. By creating new knowledge and insights, research and innovation can provide answers and solutions to these different societal challenges.

However, access to high-quality research infrastructure is vital for providing research opportunities and the ability to create knowledge and technologies. Such infrastructure attracts top scientists and makes it possible to carry out groundbreaking research.

Technological change is accelerating today at an unprecedented rate. It is creating a whole new world. As a consequence of this immense progress, research infrastructure is becoming more complicated and consequently, more expensive. That is why the Flemish government is continuing to invest in decent infrastructure. It is the only way to create and maintain a modern research-friendly environment and ecosystem.

A history in excellence

Flanders has a long history of investing in research and innovation infrastructure.

Since 2007, Flanders has financed large-scale research infrastructures. In 2009, the first Flemish priority list was established for participation in the European Strategy Forum for Research Infrastructures (ESFRI).

With the Big Science programme, the Research Foundation – Flanders (FWO) supports research projects performed at international research facilities. Since 2008, as part of that Big Science programme, the federal and Flemish governments have been supporting international projects at national and international facilities.



The common
facts of today are
the products of
yesterday's research.

Duncan Macdonald

In 2018, the Research Foundation – Flanders (FWO) and the Department of Economy, Science and Innovation joined forces. Each organization focuses on its own assignment in order to streamline support programmes for large-scale research infrastructures. This resulted in two complementary programmes: 'Flemish Large-scale Infrastructures' and 'International Research Infrastructures'.

Throughout this period, excellence has always been key. It remains our goal and will be in the coming years. It is our guiding light for encouraging internationalization and the development of new research infrastructures.

Our goal

In previous legislatures the Flemish government always had knowledge creation and innovation as a priority, resulting in a strong budgetary growth path. The current Flemish government is continuing to pursue these ambitions and continuing to invest.

The goal is to achieve the 3% standard in R&D investment in Flanders by the end of this legislature. By 2024, there will be 250 million euro extra for research and development on a yearly basis, and 195 million euro extra for investments in research infrastructure.

Investments in R&D infrastructure will be a priority for the Flemish government for the next five years. Collaboration is essential for these investments to have a genuine impact. A long-term strategic and Flemish vision on research infrastructure will be prepared and continually updated in collaboration with industry and the complete research landscape (universities ... etc.).

Flemish road map for research infrastructure

The next step is to work on a landscape analysis of the institutional, regional and international research infrastructures in order to achieve the first Flemish road map for research infrastructure. In collaboration with the Flemish research community and under the guidance of a committee, we will be commencing this project in 2020.

With this publication we offer you, for the first time, an overview of the existing and new international research infrastructure in Flanders. The large-scale research infrastructure, in which the Flemish government has invested since 2011, is also covered.

Great ambitions lead to great research and great research to great progress. Progress from which we can all benefit. But to make this happen, adequate information and communication is necessary at every step. Let this publication be the first step.

HILDE CREVITS

*Vice-Minister-President of the Government of Flanders,
Flemish Minister for Economy, Innovation, Work,
Social economy and Agriculture*



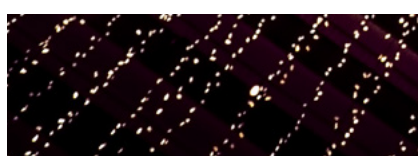
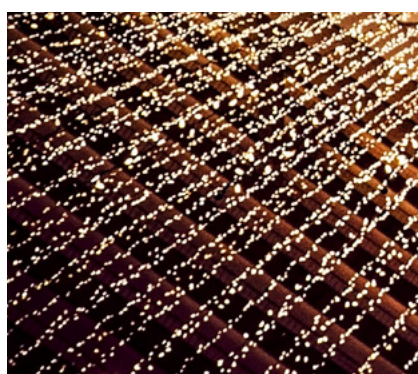
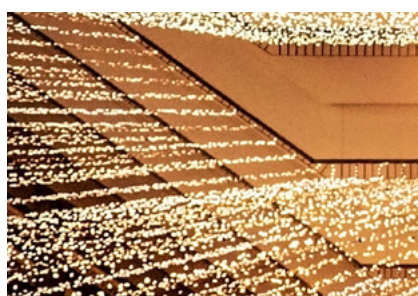
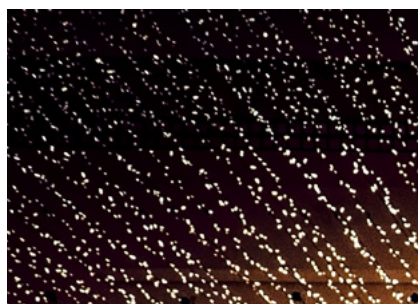

THIS IS FLANDERS

Research infrastructures: our model	10
Flemish science policy within Belgium	14
Goals for the future	18

INTERNATIONAL RESEARCH INFRASTRUCTURES

Energy 22

COB	22
-----	----

Environment 24

DiSSCo-Flanders	24
ICOS	26
LifeWatch.BE	28

Health and food 30

AnaEE-Flanders	230
ELIXIR-Belgium	32
EMBRC	34
FBI	36
Nanobodies4INSTRUCT	38

Physical sciences and engineering 40

CMS	40
ESRF (EBS), DUBBLE	42
ET	44
GANIL SPIRAL2	46
IceCube	48
ISOLDE	50
METIS	52

Social and cultural innovation 54

DARIAH-BE	54
ESS	56
SHARE	58

Digit 60

VSC-EuroHPC	60
-------------	----

LARGE SCALE RESEARCH INFRASTRUCTURES

Energy

64

PolyLine

64

Health and food

66

3teslaMRI

66

Caps-It

68

Cryo-TEM

70

KU Leuven FACS Core Facility

72

NextGenQBio

74

PacBio Sequel I

76

PHENOVISION

78

Q-MIP

80

SPHYNX

82

Physical sciences and engineering

84

Combined TOFSIMS-in situ SPM instrument

84

Flemish Atom Probe User Facility

86

Freeform Optics

88

HAXPES-lab

90

HyLaForm

92

Lena Clean Room

94

MC-ICP-MS

96

Multi-Nano

98

NMRCORE - NMR for CONvergent REsearch

100

PaRtiCLE

102

XCT-Centre

104

Social and cultural innovation

106

Library of Voices

106

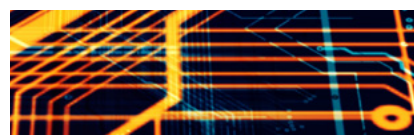
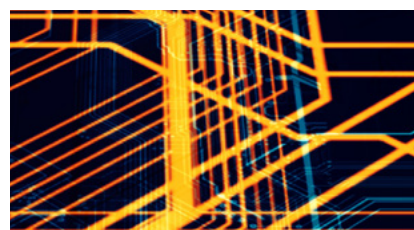

THIS IS FLANDERS





**THIS IS
FLANDERS**





Research infrastructures: our model

In the international competition for knowledge and talent, the availability of high-performance research infrastructure—the very cornerstone of the knowledge economy—is becoming more and more of a critical factor for success. Excellence in research is only ever possible through excellent, state-of-the-art research infrastructure.

Research infrastructure is broadly defined as 'all facilities and sources that promote the performance of groundbreaking and strategic, basic research, and this in all scientific disciplines'. This definition is also understood to include collections, natural habitats, corpora and databases (including digital access). They can be single-sited, distributed or virtual.

The financing of research infrastructure is aimed at strengthening the innovative character of Flanders through greater collaboration between the various stakeholders. For Flanders, it is always important that public research centres can access infrastructure with an international reference. This is essential if we are to stay on top and remain attractive to (international) researchers and companies.

The Flemish policy relating to research infrastructure has been taken to heart by two entities. The Research Foundation – Flanders (FWO or Fonds Wetenschappelijk Onderzoek-Vlaanderen in Dutch) and the Department of Economy Science & Innovation (EWI or Departement Economie, Wetenschap en Innovatie in Dutch).

The EWI is the liaison with the relevant minister. It drafts policy and is responsible for regulations. It represents Flanders in the Belgian consultative bodies and expresses the Flemish/Belgian standpoint at international forums.

The FWO supports fundamental and strategic, basic research in Flanders. The three complementary financing instruments of the FWO for research infrastructure are: the programme for medium-scale research infrastructure; the programme for large-scale research infrastructure; and the programme for international research infrastructure (IRI).

Medium- and large-scale research infrastructure

Medium-scale research infrastructure financing includes investment initiatives below one million euro. The programme for large-scale research infrastructure includes investment initiatives above one million euro. And the programme for international research infrastructure includes financing for infrastructure in an international framework.

The programme for medium and large-scale research infrastructure finances the costs for the purchase of or the construction of the infrastructure, as well as providing a budget to cover a part of any maintenance costs and upgrades, and specialized technical personnel for the servicing and maintenance of the infrastructure. In the application, a user plan and the access possibilities to the infrastructure need to be described.



The purchase and exploitation of large-scale research infrastructure often surpasses the possibilities of an individual institution. Strategic collaboration is therefore encouraged

For the large-scale infrastructure programme, calls are made every two years, resulting in competition across all disciplines on the Flemish level. Applicants must belong to a research group from a Flemish university, from a higher-education institution that performs scientific research (by the Codex Hoger Onderwijs from 11 October 2013), or from strategic research centres. A collaboration between these institutions or a collaboration with at least one of these institutions and one or more third parties is also possible.

The purchase and exploitation of large-scale research infrastructure often surpasses the possibilities of an individual institution. Strategic collaboration is therefore encouraged. A request for subsidies in the framework of the call for large-scale

research infrastructure can therefore be an institutional request (from one single institution), a consortium request, or one of the preceding types, where one or more third parties are involved in the project. Third parties can make use of an infrastructure in exchange for a financially valuable contribution. They cannot actually receive any subsidies. The collaboration between the research centres and corporations or third parties is honoured by applying a progressive financing percentage of 70% (no collaboration) to 90% (collaboration between research centres) up to 100% if a company takes on at least 25% of the costs.

Companies are therefore not permitted to receive any subsidies themselves, but receive user rights or assistance in the development of an apparatus.

International research infrastructure

Until 2018, the Flemish instruments for financing of and/or participation in international research infrastructures consisted of three co-existing instruments or financing programmes:

- Research infrastructure linked to international collaborations, including ESFRI;
- Participation in Big Science projects;
- Other participation in international infrastructures.

The decree of the Flemish Government regulating the Flemish participation in and/or the subsidising of international research infrastructures from 19 January 2018 brought changes. The decree groups, streamlines, updates and lays a structural basis for a new programme of international research infrastructure that replaces the three instruments that previously existed.

Since 2018, the IRI call has been launched every two years. The successful requests determine which international infrastructures Flemish researchers participate in and therefore confirms which infrastructures will have Belgian participation.

Via the IRI programme, long-term financing of the participating researchers is guaranteed. The programme is aimed at supporting participation in ESFRI projects, ESFRI landmarks, other international infrastructures or international projects in development.

The subsidies in the IRI programme are employed for the participation in and the financing of research infrastructure and for the institutional, operational and logistic costs of Flemish research groups that participate in it.

Expenditure for the performance of the actual research cannot be estimated on the international infrastructure programme, but can be requested via other financing channels. The federal government guarantees the payment of the membership fee.

Eligible organizations are any research group or research groups from a Flemish scientific institution, from a Flemish university, from a strategic research centre, from an institution for post-initial education, from the Flanders Marine Institute, from the KMDA-CRC (the Centre for Research and Conservation Zoo-Antwerp) from the Meise Botanic Garden, from a Flemish museum with a research assignment, or a collaboration between at least one of the aforementioned institutions and one or more third parties. A third party is broadly defined and not limited to corporations or research centres in Flanders. They cannot receive any subsidies, but may receive a real, financially appreciable contribution in the project in exchange for the (limited) right to use or access.

The IRI programme for participation in international research infrastructures therefore supports Flemish participation in a great variety of infrastructures via the same single framework, and finances as well as deciding on the level of Flemish participation.



Excellent research is only ever possible through excellent, state-of-the-art research infrastructure.

Flemish science policy within Belgium

The Belgian political governance model

Institutionally, Belgium is composed of three linguistic communities (the Flemish, the French and the German-speaking) and three distinct geographic regions (the Flemish, the Brussels-Capital Region and the Walloon). Policy-making within the country is prepared and executed by various authorities, based on three distinct pillars, each with its own range of competencies: a federal, a community and a regional pillar.

The Belgian form of federalism is unique in the world. Its defining characteristics:

- Each entity has exclusive powers and competencies in various areas;
- Each entity has its own separately elected parliament, government, administration, legislation, advisory bodies, etc.;

- No hierarchy exists between the different entities regarding their competencies (no supersession is possible);
- Since the fourth state reform of 1993, the principle of “in foro interno, in fore externo” has been applied, meaning that each entity executes its competencies both inside and outside Belgium.

Flanders is both the autonomous Flemish region as well as the Flemish community, and is located in the northern part of Belgium, with Brussels serving as its capital. Since 1980, a single Flemish parliament, Flemish Government, and administration, with consultative or advisory bodies, have managed and overseen both community and regional competencies in the various

policy domains. This is contrary to the Walloon side of Belgium where the region and the community have their own governing bodies and parliament.

In the field of science, technology and innovation, competencies have gradually shifted from the federal government to the regions and communities. Now the regions and communities are competent for the majority of science, technology and innovation policies. The federal government still has competencies for research linked directly to its other competencies, and additionally the federal government is exclusively competent for a limited number of research themes, most notably the space and nuclear fields.

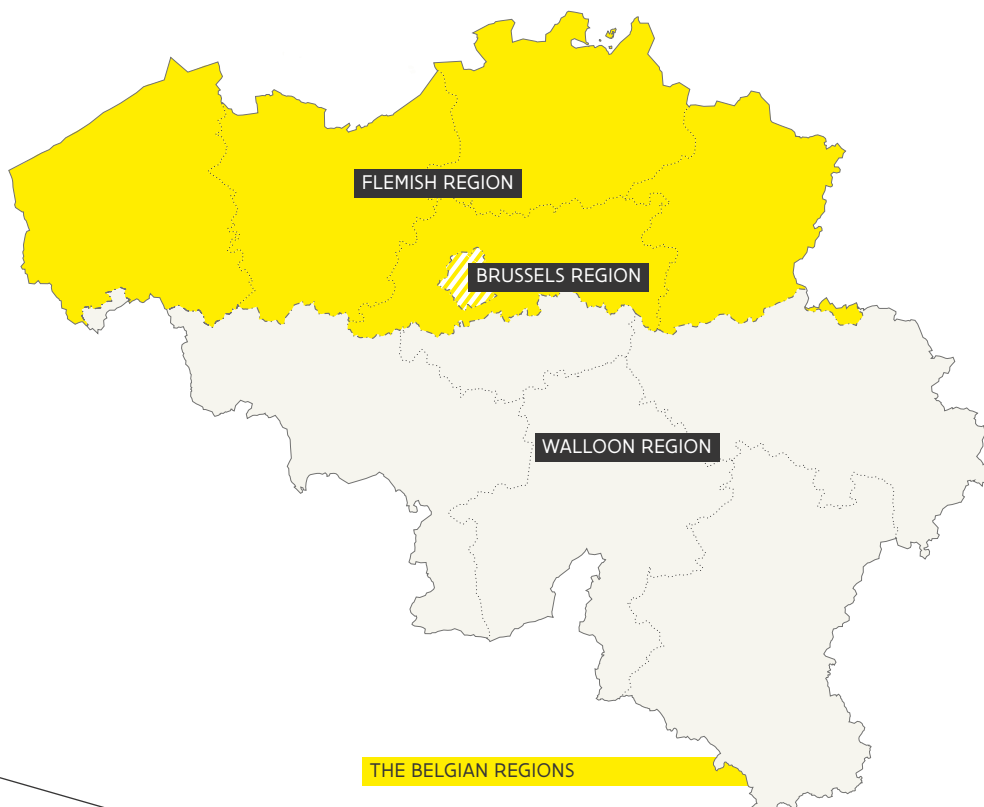

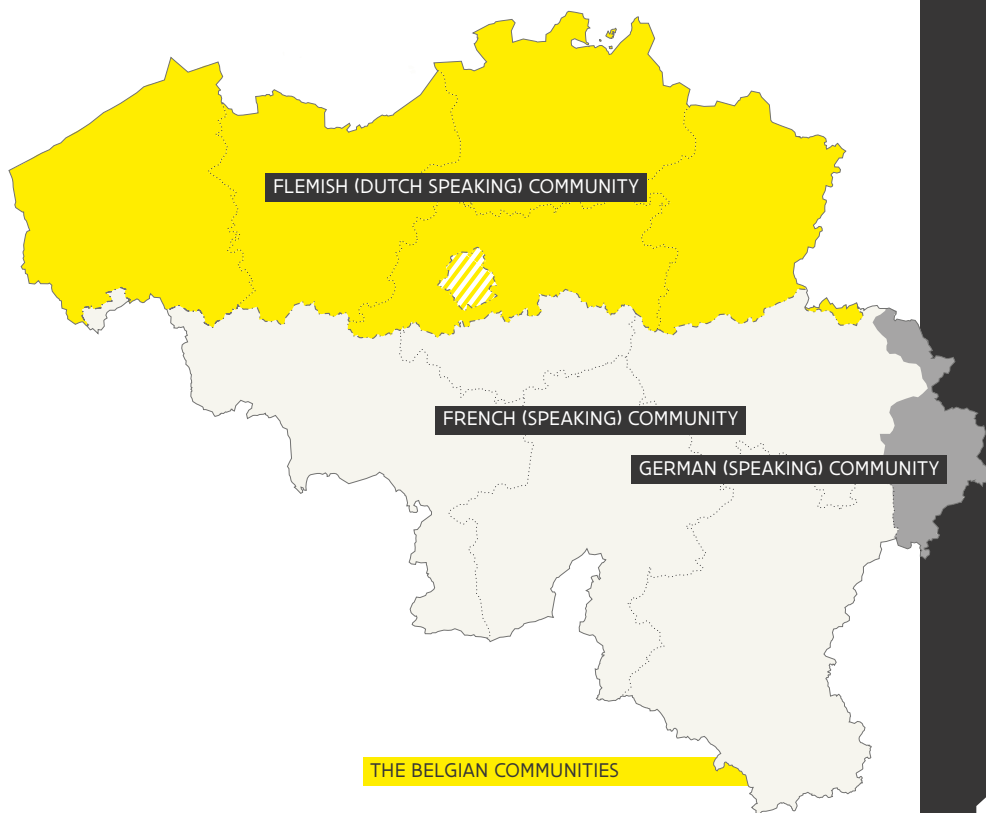

Under the policy for “Belgian” participation in international research infrastructures, each entity has its own decision-making powers over its own research competencies. This means that in some research infrastructures, the institutional participation is limited to one of the entities, open to more than one, or to all of them. The decision on these participations is consolidated in the commission for international cooperation and confirmed by the inter-ministerial conference.

A more elaborated explanation of Belgium’s constitutional and governance model can be found in the publication ‘STI in Flanders 2020; Science Technology & Innovation; Policy and Key Figures (in press).

Thus far, the federal government guarantees the membership fees of Belgian participation in international research infrastructures. The entities provide the budgets required for the research infrastructures for their own institutions and as well as all means necessary to make participation possible.

As all entities are independent, they have their own governance model and research funding programmes for scientific policy. For more than a decade, Flanders has invested strongly in state-of-the-art research infrastructures supporting its research programmes: medium-scale, large-scale and international research infrastructures (see below).

The following schedule presents the public bodies that are active in the Science Technology and Innovation field in Flanders as of 2020.



Since more than a decade Flanders has invested severely in state of the art research infrastructures supporting its research programmes: medium-scale, large-scale and international research infrastructures.

Department of Economy, Science & Innovation (EWI)

Like all the policy areas under Flemish authority, the EWI policy area is composed of one (policy preparation) department and several (policy execution) agencies.

The role of the EWI Department is to prepare, monitor, evaluate and report on public policy in the field of enterprise (economic support and entrepreneurship), science and innovation, thereby contributing to greater wealth and well-being in Flanders. It promotes:

- excellence in scientific research;
- an attractive and sustainable business climate;
- a creative, innovative and entrepreneurial society.

The strategic aims of the EWI Department for Science, Technology and Innovation (STI) are:

- to create a sustainable economic tissue and facilitate entrepreneurship;
- to stimulate innovation and creativity;
- to stimulate knowledge creation and knowledge valorization;
- to put Flanders on the international map in the field of economy, science and innovation;
- to develop itself as a knowledge centre within the Flemish authority on the basis of delivering and using insights in the field of economy, entrepreneurship, scientific research and innovation.

More specifically, within the STI field, the EWI Department:

- coordinates all R&D&I topics inside and outside the Flemish Government, including activities involving work groups in Horizon 2020 on behalf of the Flemish Community and in the ESFRI forum.

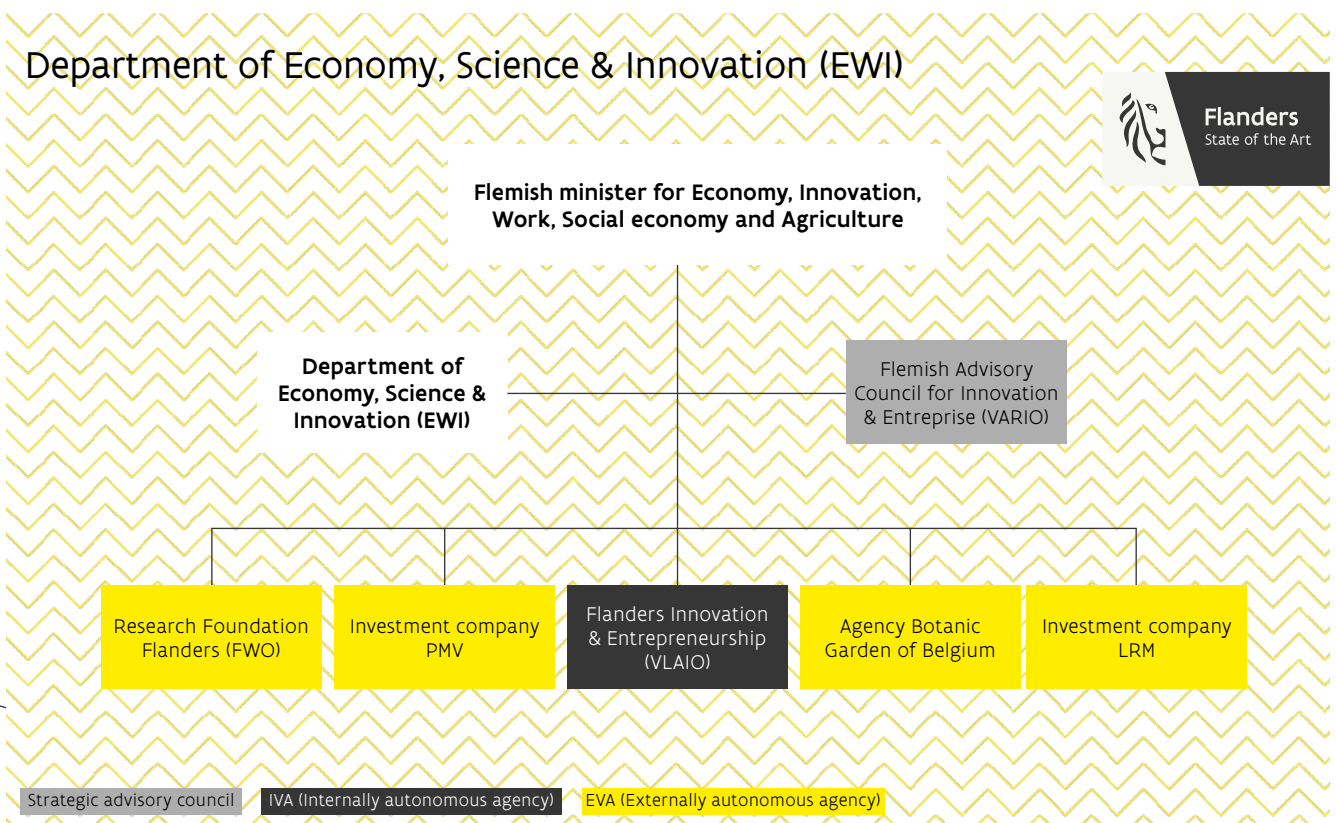

Research Funding Agencies

While departments of the Flemish Government prepare, monitor, evaluate and report on public policy, a few agencies are responsible for the implementation of the policy decisions.

In the STI field, these agencies have established a wide variety of initiatives and support instruments for implementing policy. The main agencies funding research in Flanders are:

- VLAIO: Flanders Innovation and Entrepreneurship;
- FWO: Research Foundation – Flanders.

Flanders Innovation & Entrepreneurship (VLAIO) Flanders Innovation and Entrepreneurship (Agentschap Innoveren en Ondernemen in Dutch) is a government agency, charged with implementing the economic, innovation and corporate policy in Flanders. It helps companies with the start up of their activities, the growth and continuity of their businesses, but also with the search for the right location, information on permits, financing, investments in innovation and ecological technologies, and other topics. VLAIO also hosts the Enterprise Europe Network (EEN) Flanders, and acts as the managing authority for the EU ERDF calls and support in the Flemish Region.

Research Foundation Flanders (FWO)

The Research Foundation Flanders (FWO – Fonds Wetenschappelijk Onderzoek Vlaanderen in Dutch) supports fundamental and strategic scientific research and research infrastructures. It also stimulates international cooperation. Researchers can apply for support from FWO through a broad range of funding instruments. The only criterion is to demonstrate outstanding quality of the researcher and the research proposal.

The FWO now manages support for:

- fellowships and support for research projects;
- strategic basic research;
- clinical-scientific research;
- research infrastructure.

In short

VLAIO

In short, VLAIO manages all economic and innovation support for companies located or active within the Flemish region. VLAIO was established in 2016 after a merger of the Agentschap Ondernemen (AO, Enterprise Flanders) with the Agentschap voor Innovatie door Wetenschap en Technologie (IWT, Agency for Innovation by Science and Technology).

FWO

In short, the support instruments from the FWO are:

- PhD fellowships, fundamental and strategic basic research;
- postdoctoral fellowships;
- research projects;
- research infrastructure (medium-scale, large-scale, international);
- international mobility (outgoing, incoming);
- international collaboration (exchange agreement, scientific cooperation, bilateral research co-operations, 'Lead Agency' procedures);
- international contacts (international coordination action, organization of a scientific conference in Belgium, scientific research network (WOG));
- scientific prizes (a wide range, and in different domains);
- European programme involvement (e.g. FWO is the Flemish contact for COST and acts together with the Flanders Innovation & Entrepreneurship (VLAIO) as National Contact Point (NCP) within the EU's 'Horizon 2020' programme).

Goals for the future

Investing in the future of Flemish R&D

In 2003, via the so-called Innovation Pact, the Flemish government set the objective of spending 3% of regional GDP on research and development (R&D). In the time since, with successive Flemish governments committing to constant budget increases for R&D, this goal has been sustained.

This continued commitment to increasing investments in R&D is clearly bearing fruit today. Companies see the importance of R&D for their competitive positions. This has led to private investments in R&D that have transcended the European goal of 2%. The services sector has not been left out. Their role in the Flemish R&D landscape has become increasingly more important. The government is also continuing its efforts and systematically increasing the budgets for research at universities, research institutions and scientific institutions.

On the basis of the most recent figures – requested via surveys for the 2016 and 2017 spending years – the R&D intensity for 2017 constitutes 2.89% of the GDP.

At 0.72%, public funds are still below the goal (1% of the GDP). As this relates to figures up to and including 2017, the large budgetary steps taken in 2019, which included a 19% increase on the 2018 Flemish budget amounts, is not included in these figures.



The Flemish government is ambitious in dedicating extra budget to R&D; by the end of the legislature, it will reach its objective to spend 3% of GDP on R&D.

With 2.89% of the GDP spend on R&D, we are among the highest spenders in Europe. Only Sweden, Austria, Denmark and Germany score better.

The current Flemish government (2019–2024) is also ambitious in dedicating more of the budget to R&D; by the end of the legislature, the 3% standard will have been reached. By 2024, an additional 250 million euro will be spent on research and development on a yearly basis. Across the entire legislative period, over 195 million euro will be spent on R&D infrastructure.

Excellence remains the key word for the financing of scientific research, whether it relates to encouraging internationalization or the expansion of new research infrastructure. The policy must always generate impact, and do so on all levels; scientists must find an audience of peers worldwide with their groundbreaking research results; research and entrepreneurial projects must make a concrete contribution to social and economic challenges, including better competitiveness and sustainable job creation in Flanders. Through more and better collaborations, the economic and societal potential will be fulfilled. Collaborations between companies and knowledge institutions, between research teams from institutions and companies, between scientific disciplines and sectors – and last but not least – more cross-border collaborations within Europe and areas even further afield. Flanders is investing even more in excellent collaborative ties and exchange programmes with the best research institutions from Europe and across the world. With adequate research instruments, the participation of our knowledge institutions in international programmes and in (inter)national research will be supported.

For the resources that the Flemish government will be spending on investments over the coming five years, investments in infrastructure for R&D will be one of the priorities. In collaboration with the research landscape (universities, Strategic Research Centres, Flemish scientific institutions, spearhead clusters, etc.), and the corporate world, a Flemish roadmap for research infrastructure will be created from a strategic, long-term perspective.

The project will be initiated in 2020, the approach will be defined in collaboration with the field and under guidance of a commission of stakeholders and experts. A landscape analysis will precede the drafting of the Flemish roadmap.



**INTERNATIONAL
RESEARCH
INFRASTRUCTURES
IN FLANDERS
2020**





**INTERNATIONAL
RESEARCH
INFRASTRUCTURES
2020**

COB

Coastal and Ocean Basin

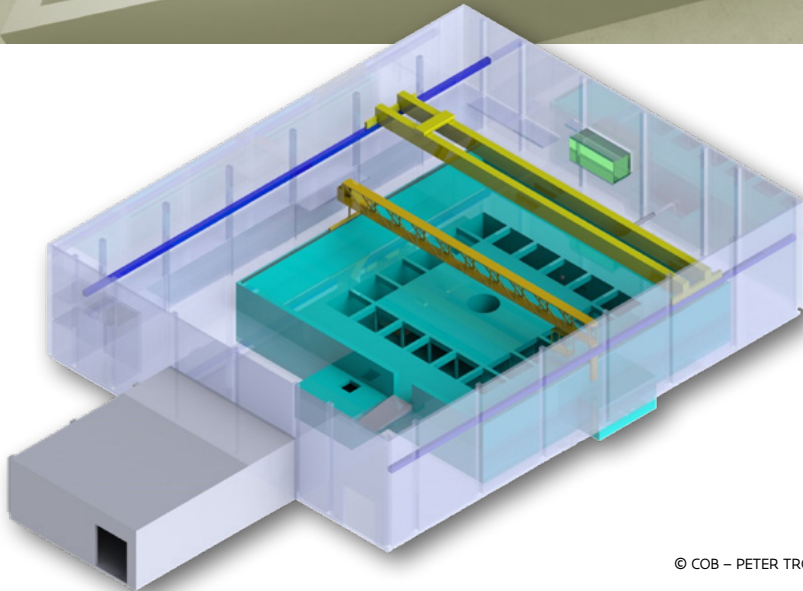
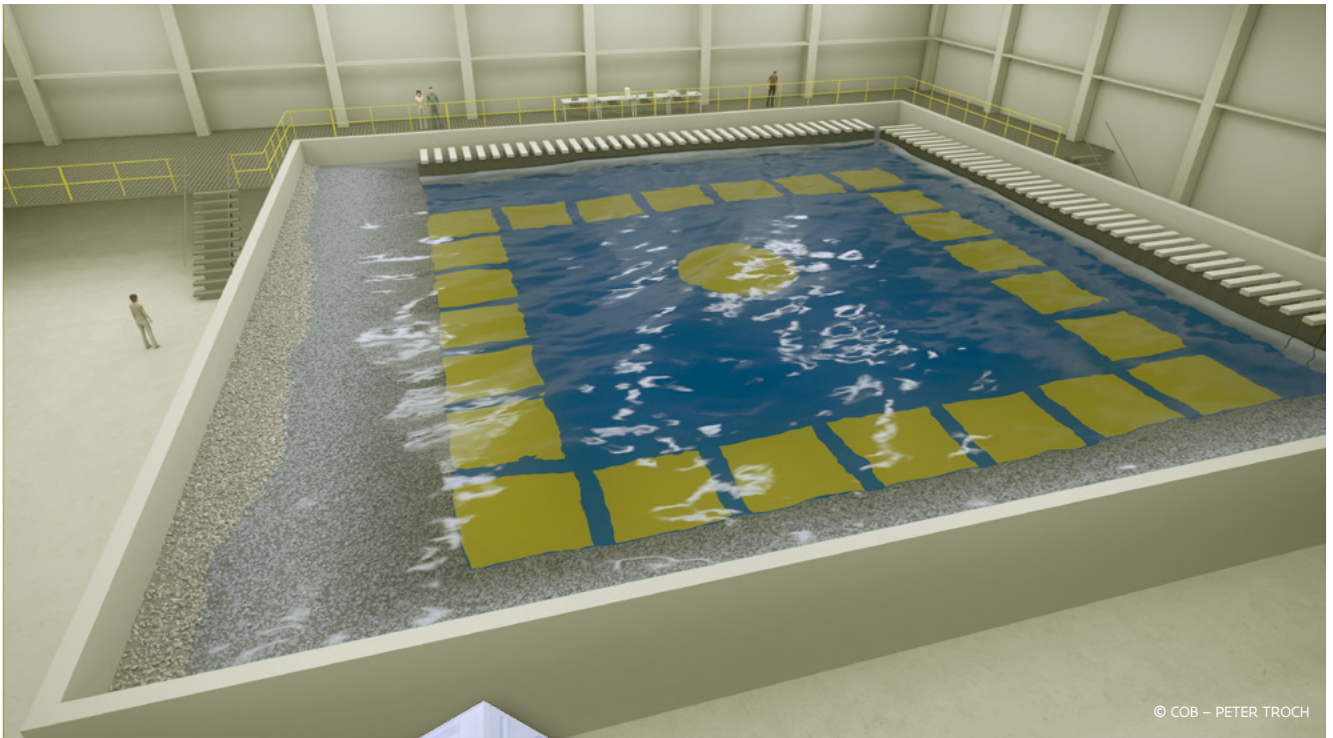

Innovative technologies from coastal, offshore and Ocean Renewable Energy (ORE) engineering will be tested in the COB under combined waves, currents and wind loads.

The COB is included in MARINERG-i which is the first step in creating an independent legal entity of distributed IRI for ORE. MARINERG-i's integrated and coordinated approach will accelerate R&D&I of wind, wave and tidal energy. MARINERG-i will strengthen scientific excellence, engineering expertise, investment and access to infrastructures, as its combined facilities represent an indispensable tool for innovation.

Ghent University is the COB coordinator, as well as the National Node in the MARINERG-i context.

COB

IN FLANDERS ACTIVE SINCE

2019

FIND US ONLINE

- www.cob.ugent.be
- www.marinerg-i.eu

GOOD TO KNOW

The COB is included in the research infrastructures of the MARINERG-i project. The MARINERG-i consortium will submit its new application for the ESFRI Roadmap 2021.

CONSORTIUM

Coordinator of the Flemish consortium

Peter Troch

Department of Civil Engineering
Ghent University
Peter.Troch@UGent.be
+32 9 264 54 89

Consortium members

- **Jaak Monbaliu**, KU Leuven,
Jaak.Monbaliu@kuleuven.be
- **Frank Mostaert**,
Flanders Hydraulics Research,
frank.mostaert@mow.vlaanderen.be



Activities, Equipment and Services

The COB is a wave tank that allows users to conduct tests for coastal and offshore (energy) engineering for research and commercial projects, in collaboration with knowledge institutes, governments and the industry. The facility has dimensions of 30.0 x 30.0 x 2.5m (L x W x H) and a deep central pit. It is equipped with state-of-the-art instrumentation technology. Waves, currents and wind (as well as their combinations) are generated in an artificial way at various model scales and relative directions.

The COB provides services for testing interaction between waves/currents/winds and engineering concepts or structures used for: coastal and harbor engineering, coastal protection against climate change impacts and floods, nature-based coastal protection solutions, offshore floating and fixed structures, and ocean renewable energy technologies.

Impact and Importance

The COB RI plays a strategic role in Belgium (largest infrastructure of its kind) and in Europe, due to its key technical characteristics and the large number of stakeholders and end-users.

The COB meets R&D&I needs from academia, governments and industry. Ostend is a hub of coastal and offshore engineering activities and of the related industry; the COB is an important player in the area.

The MARINERG-i project will strengthen the COB's position in the network of research infrastructures of this kind, ensuring a dynamic start-up of the new COB infrastructure.



The COB is a unique infrastructure in Belgium. It will become a coastal, offshore and ocean renewable energy epicentre in the wider region by attracting international users with its state-of-the-art facilities.

DISSCO-FLANDERS

Distributed System of Scientific Collections - Scientific collections unlocked!

DiSSCo is a world-class Research Infrastructure for the digital and physical curation of European natural science assets under common management and access policies. It is aimed at making data Findable, Accessible, Interoperable

and Reusable (FAIR). DiSSCo enables the transformation of a fragmented landscape into an integrated knowledge base. It represents the largest ever formal agreement between natural history museums, botanical gardens and universities that hold collections.

DiSSCo Flanders will increase the visibility and mobilisation of collections by having a consolidated Collections Management Plan following international best practices and standards. The partners are experts in collection management, biodiversity



information standards, digitization, and reference repositories like taxonomic backbones. Internationally, the partners are active in European projects, executive boards and associations in natural sciences, including taxonomy, ecology and evolution.

Activities, Equipment and Services

The current activities are about raising awareness of the importance of the natural science collections in the bio- and geo-sciences and mobilising them for DiSSCo. The first goal is to make an inventory of the collections kept in Flanders, and assess their current state of conservation and digitization using internationally approved evaluation methods such as those developed within SYNTHESYS (Synthesis of Systematic Resources).

Training courses and workshops on best practices in collection management and their digitization are organized and further planned, both in Belgium and in collaboration with international training providers. Advice and support for curation and digitization, and for the joint identification and search for additional funding sources, is also offered.

Impact and Importance

Data-driven scientific excellence and innovation in environmental research, climate change, food security, health and the bioeconomy is required to unlock this natural, cultural heritage. DiSSCo will mobilise and deliver bio- and geo-diversity information at the scale, in the form and with the precision required to transform a fragmented landscape into a coherent and responsive research infrastructure. The size and scale on which digitized collections are made available enable novel applications, such as machine learning, placing DiSSCo within the current implementation of the European Open Science Cloud (EOSC). Both collections and observations in the field have enabled exploration of the biodiversity of Tropical Africa, which has come to the conclusion that about a third of this flora is at risk of extinction. A local positive example is the rediscovery in Belgium of a plant (the giant needleleaf), long thought extinct, via the consultation of a 152-year-old herbarium sheet that had been digitized.



The better you
know biological and
geological diversity,
the better you can
preserve it.

DiSSCo-Flanders

IN FLANDERS ACTIVE SINCE

2019

FIND US ONLINE

- www.dissco.eu/be
- www.dissco.eu
- DiSSCoEU
- www.linkedin.com/company/dissco

CONSORTIUM

Coordinator of the Flemish consortium
Patricia Mergen
Meise Botanic Garden
General Administration
Patricia.Mergen@plantentuinmeise.be
+32 2 260 09 25

Consortium members

- **Aaike Dewever**, Research Institute for Nature and Forest (INBO)
- **Leen Vandepitte**, Flanders Marine Institute (VLIZ)
- **Zjef Pereboom**, Royal Zoological Society of Antwerp (KMDA)
- **Serge Scory**, Royal Belgian Institute for Natural Sciences (RBINS) and Royal Museum for Central Africa (AFRICA museum)
- **Pierre Meerts**, Université Libre de Bruxelles
- **Carine Michiels**, University of Namur



ICOS

Integrated Carbon Observation System

ICOS is a distributed research infrastructure that monitors the fluxes of carbon and greenhouse gases across the European continent. ICOS integrates highly standardized long-term and continuous greenhouse

gas measurements in more than 140 observatories distributed across 12 countries and grouped in three networks (atmosphere, land ecosystem and ocean). Flanders manages three land ecosystem stations and two

marine stations for ICOS. In addition, it co-hosts the Ecosystem Thematic Center (ETC) that coordinates the ICOS ecosystem network and provides centralized quality control and data processing.



ICOS

IN FLANDERS ACTIVE SINCE

2009

FIND US ONLINE

www.icos-belgium.be

www.icos-ri.eu

ICOS_RI
BelgiumICOS

icosri

CONSORTIUM

Belgian National Focal Point (NFP)

Ivan Janssens

University of Antwerp
Plants and Ecosystems (PLECO)
ivan.janssens@uantwerpen.be
+32 3 265 22 55

Consortium members

- **Martine De Mazière**, Royal Belgian Institute for Space Aeronomy (BIRA-IASB)
- **Maurice Hoffmann**, Research Institute for Nature and Forest (INBO)
- **Thanos Gkritzalis**, Flanders Marine Institute (VLIZ)
- **Lieven Naudts**, Royal Belgian Institute of Natural Sciences (RBINS)
- **Bernard Heinesch**, University of Liège (ULG)



Activities, Equipment and Services

The atmospheric, land and marine observatories collect data on greenhouse gases and a large suite of relevant ancillary data that is helpful to its interpretation. Raw data is transferred to the respective Thematic Centers, where it undergoes quality controls and processing. The one-stop ICOS Carbon Portal renders all data freely and easily accessible to all users.

Flanders has constructed five observatories, three on land, including a poplar-based bio-energy plantation and a heath (both unique in the ICOS network), and one of the longest-running flux observatories (in operation since 1996). The two marine observatories include the VLIZ Thornton buoy and the research vessel 'Simon Stevin'. These ICOS observatories also serve as platforms for hosting researchers and trainees, and for driving the development of novel greenhouse gas instruments.

Impact and Importance

The President of the European Council recently declared that Europe is aiming for carbon-neutrality by 2050. The European Commission asked the Copernicus Programme to develop an operational CO₂ emission detection and verification system, which member states will have to implement.

Both initiatives require greenhouse-gas data of the highest possible precision and accuracy to verify the effectiveness of policy measures and ground-truth remote sensing products. ICOS provides this data.

The high-quality and standardized ICOS data is also extremely valuable for advancing science, not only in biogeochemistry, but also in climatology, air chemistry and pollution, atmospheric physics, and ecosystem functioning.

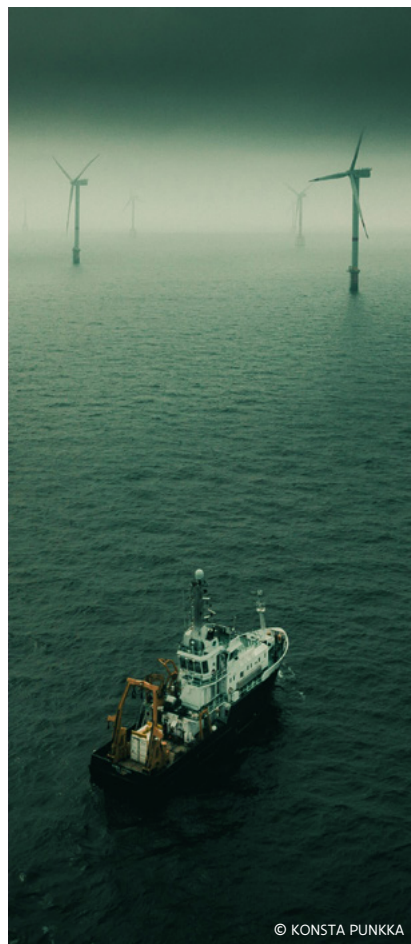

ICOS: Climate
knowledge through
greenhouse gas
observations.

LIFEWATCH.BE

A Flemish marine, terrestrial and freshwater observatory for biodiversity, models and data systems, including a central backbone with species information.

LifeWatch is a pan-European distributed e-Science Infrastructure providing services in support of biodiversity research and ecosystem studies. LifeWatch aims to advance biodiversity research and support knowledge-based solutions for

environmental preservation. These objectives are achieved by providing access to a multitude of data, services and tools, enabling the construction and operation of Virtual Research Environments (VRE).

Flanders provides key components, delivering the Species Information Backbone as a central European node, and contributing local services by running the marine, freshwater and terrestrial observatories. In addition, Flanders has a pivotal role in the



LifeWatch.BE

IN FLANDERS ACTIVE SINCE

2010

FIND US ONLINE

- www.lifewatch.be
- www.lifewatch.eu
- [lifewatchvliz](#)
- www.lifewatch.be/en/news

CONSORTIUM

Coordinator of the Belgian consortium
Klaas Deneudt
VLIZ-Flanders Marine Institute
klaas.deneudt@vliz.be
+32 59 34 13 12

Consortium members

- **Tanja Milotic**, Research Institute for Nature and Forest (INBO)
- **Julien Radoux**, Université Catholique de Louvain - Earth & Life Institute (UCLouvain ELI)
- **Marc Dufrière**, University of Liège/ Gembloux- Agro Bio Tech, Biosystems Engineering Department (ULiège)
- **Anton Van de Putte**, Royal Belgian Institute of Natural Sciences (RBINS)
- **Thierry Backeljau**, Royal Museum for Central Africa (RMCA)

marine activities, leading developments on the Marine VRE.

Activities, Equipment and Services

A prominent service by Flanders supporting the Central LifeWatch activities is the Species Information Backbone. The Species Information Backbone facilitates integrated open access to high-quality species information and data across Europe and globally. It is kept up to date and operational through continuous system optimisation, data management and community support from data providers.

Flanders makes a large-scale regional contribution by operating marine, terrestrial and freshwater observatories. These observatories use innovative and integrated observation systems to generate openly accessible long-term biodiversity data that is used intensely. The acoustic, imaging and GPS tracking data flows seamlessly through a state-of-the-art big data e-infrastructure for processing, storage and user access.

For the efficient processing of the large volumes of collected data, artificial intelligence solutions are being developed. Complementary services on remote-sensing-based habitat mapping, Antarctic biodiversity observations and the genetic identification of species are provided by Wallonia-Brussels and by contributions at the federal level.

Impact and Importance

LifeWatch, as a whole, is a revolutionary development that plays a key role in understanding and managing changes in biodiversity, crucial for the sustainable development and exploitation of Europe's resources in relation to climate change and global environmental changes in general.

Flanders' Species Information Backbone contributes services to R&D in the areas of land-use planning, environmental management, nature conservation, invasive species control, agriculture, health and safety, natural products, pharmaceuticals, biotechnology, etc. Consulted worldwide by thousands of users daily and through uptake in over 800 publications each year, the science and policy impact is clearly enormous.

The observatory activities generate important internationalization and multiplication effects for Flanders' research capacity. Furthermore, there is a demonstrated impact towards industry with the application of the innovative observation capabilities, technological spillover and supporting Blue & Green Growth projects that have been developed. Management and conservation are supported by the underpinning of biodiversity indices. Finally, there is a growing interaction with civil society through the engagement in citizen science approaches and participatory monitoring.



Digital innovations
for knowledge-
based solutions
for and through
biodiversity.

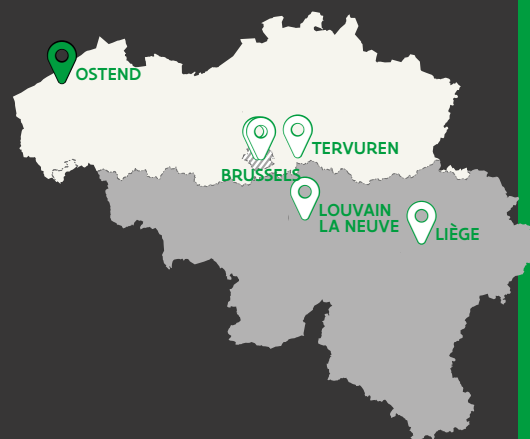

ANAEE-FLANDERS

Analysis and Experimentation on Ecosystems, Flanders

AnaEE is a research infrastructure for the experimental study of managed and unmanaged terrestrial and aquatic ecosystems. It supports scientists in their analysis, assessment and forecasting of the impact of climate and other global changes on the

services that ecosystems provide to society. AnaEE is a distributed infrastructure, with experimental, analytical and modelling platforms scattered throughout Europe (including 3 new platforms in Flanders), allowing researchers to study a range of

ecosystems in a range of climates. This is important for avoiding context dependence in findings. Services organised by the Central Hub and the three thematic centres provide further added value to scientists and stakeholders.



AnaEE-Flanders

IN FLANDERS ACTIVE SINCE

2016

FIND US ONLINE

www.anaee.com

www.globalchangeecology.blog

[AnaEE - Analysis and Experimentation on Ecosystems](#)

GOOD TO KNOW

Active experimental platforms in Belgium

- Ecotron Hasselt University
- Ecotron Gembloux
- Infrared Heating Systems Antwerp
- Mesodrome, including Flume Antwerp

CONSORTIUM

Coordinator of the Flemish consortium

Ivan Nijs

University of Antwerp
Plants and Ecosystems
ivan.nijs@uantwerpen.be
+32 3 265 22 57

Consortium members

- **Jaco Vangronsveld**, University of Hasselt, jaco.vangronsveld@uhasselt.be
- **Bernard Longdoz**, Université de Liège, Bernard.longdoz@uliege.be

Activities, Equipment and Services

The Belgian AnaEE platforms are new infrastructures, offering highly controlled environments and a range of automated measurements. The two Ecotrons and the Infrared Heating Systems focus on terrestrial ecosystems, from (semi-)natural to agricultural systems, and enable the imposition of a variety of climate change scenarios, coupled with other relevant drivers (e.g. changes in nutrient inputs). The Flume artificial river and ponds in the Mesodrome extend the scope towards the aquatic environment, where climate change (e.g. through peak flows) and pollution can have large-scale impacts, both biotic and abiotic.

The Hub and AnaEE-Europe Centres increase the visibility and optimize the international use of the platforms, improve their technological and experimental capacities, enhance data quality, accessibility and integration,

stimulate modelling activities, organise training, network with stakeholders and deliver syntheses.

Impact and Importance

Experimentation is invaluable for improving predictions of how global changes (especially climate change) will affect various natural and man-made ecosystems. In the domain of global change ecology, the current set of complementary, high-tech platforms within Flanders and Belgium are important in areas that extend well beyond strengthening ecological theory. The research made possible by the platforms has strong ties to society and economy; it facilitates detailed studies on safeguarding agricultural yields or better water management in the context of environmental changes that threaten a range of ecosystem services. The RIs reinforce Flanders' position as a prime region for scientific research on environmental issues and bio-economy.



Human adaptation to global change requires experimentation on ecosystems where future conditions are simulated.



ELIXIR-BELGIUM

A distributed infrastructure for life-science information



ELIXIR services enable scientists to store, annotate, analyse, share, and reuse biological data for innovative research.

ELIXIR-Belgium

IN FLANDERS ACTIVE SINCE

2016

FIND US ONLINE

www.elixir-belgium.org

www.elixir-europe.org

[ELIXIRnodeBE](#)

bit.ly/2YavwyU

CONSORTIUM

Belgian Head of Node (HON)

Frederik Coppens

VIB-UGent Center for Plant Systems Biology
frederik.coppens@elixir-belgium.org
+32 9 331 38 12

Consortium members

- **Yves Van de Peer**, Bioinformatics and Evolutionary Genomics, VIB-UGent Center for Plant Systems Biology & Department of Plant Biotechnology and Bioinformatics, Ghent University
- **Yves Moreau**, ESAT - STADIUS, Stadius Centre for Dynamical Systems, Signal Processing and Data Analytics, Katholieke Universiteit Leuven
- **Wim Vranken**, Structural Biology Brussels, Free University of Brussels
- **Dirk Valkenburg**, Center for Statistics, University of Hasselt
- **Kris Laukens**, Adrem Data Lab, University of Antwerp
- **Matthieu Defrance**, Computer Science Department, Université Libre de Bruxelles
- **Kristel Van Steen**, GIGA-R Medical Genomics Unit, University of Liège
- **Kevin Vanneste**, Transversal Activities in Applied Genomics Unit, Sciensano

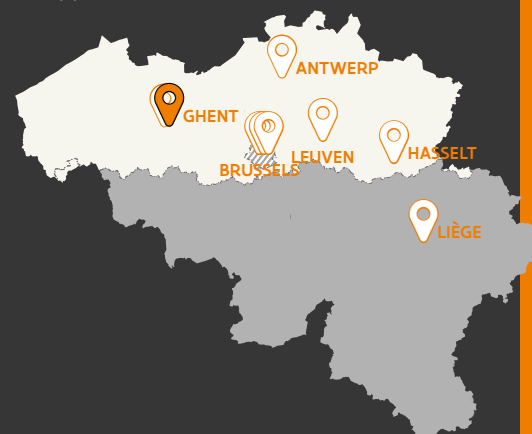

The distributed infrastructure for life science information consolidates national centres, services, and core bioinformatic resources into a single, coordinated infrastructure. ELIXIR coordinates and develops life science resources across Europe, enabling researchers to find, analyse and share data, exchange expertise and implement best practices, and gain greater insights into how living organisms work. By coordinating these resources, ELIXIR helps address the Grand Challenges in life sciences, from marine research – via plants and agriculture – to health research and medical sciences.

In 2013, ELIXIR became a permanent legal entity following the ratification of the ELIXIR Consortium Agreement by EMBL and the first five funding countries. At present, ELIXIR includes 22 countries and an inter-governmental organisation (EMBL) – referred to as the Nodes. It drives the implementation of the European Open Science Cloud (EOSC) for the life sciences domain.

Activities, Equipment and Services

ELIXIR is a distributed Research Infrastructure that builds on existing data resources and services across Europe. The Nodes build on the strengths of the scientific communities of the respective country. Resources include: data repositories; added-value databases; computer centres; services for the integration of data, software, tools and resources; education and training; standards, ontology and data management expertise.

ELIXIR Belgium focusses on domain-specific services in plant sciences, human health and proteomics, and plays leading roles in the ELIXIR Galaxy and Proteomics Communities. FAIRification of research data and facilitation of reproducible analysis is pursued through activities in data management and analysis, as well as training, both in Flanders and on the European level (EOSC-Life project).

Impact and Importance

Industry has great interest in, and use of, European bioinformatics resources. This has been demonstrated by the millions of hits from commercial users to the websites of ELIXIR Nodes and the number of patents that reference life science databases. ELIXIR's Innovation and SME programme ensures that high-tech companies across Europe can access the services run by ELIXIR partners.

Open life science data has large-scale societal value and truly facilitates researchers in solving the Grand Challenges. For example, the development and validation of drug-design tools, many of which have been successfully commercialised, has relied on carefully curated datasets extracted from publicly archived data resources such as the Protein Data Bank.

EMBRC

European Marine Biological Resource Centre



EMBRC-ERIC is a European Research Infrastructure Cluster that provides and supports large-scale, high-quality marine biological and ecological research in Europe. It was established to address Europe's challenges related to food, health and global change. By participating in EMBRC, Flanders remains at the front lines of Blue Growth, with fundamental

and applied research and education activities in sustainable use of marine living resources, blue biotechnology, ecosystem health and marine ecosystem management. Flanders is taking part in the Belgian Node via four operators, each providing unique infrastructure and services in line with the goals of EMBRC-ERIC.

EMBRC

IN FLANDERS ACTIVE SINCE

2013

FIND US ONLINE

www.embrc.be

www.embrc.eu

[embrc_eu](https://twitter.com/embrc_eu)

CONSORTIUM

Belgian Head of Node (HON)

Ann Vanreusel

Ghent University

Marine Biology Research Group

embrc@ugent.be

+32 9 264 85 21

Consortium members

- **Jan Mees**, Flanders Marine Institute
- **Tom Artois**, Zoology, Biodiversity and Toxicology, Hasselt University
- **Philip Volckaert**, Biodiversity and Evolutionary Genomics, KULeuven
- **Wim Vyverman**, Protistology and Aquatic Ecology, Ghent University
- **Anne Willems**, Microbiology, Ghent University
- **Jana Asselman**, Environmental Toxicology and Aquatic Ecology, Ghent University
- **Gilbert Van Stappen**, Aquaculture & Artemia Reference Center, Ghent University
- **Koen Chiers**, Veterinary Medicine, Ghent University
- **Olivier De Clerck**, Phycology, Ghent University
- **Jan Vanaverbeke**, Aquatic and Terrestrial Ecology, Royal Belgian Institute of Natural Sciences



Activities, Equipment and Services

EMBRC-ERIC aims to be a global reference research infrastructure for fundamental and applied marine biology and ecology research. It serves as a single entry point to a unique range of services, resources and knowledge. Flemish operators contribute with several fundamental, expert-based and state-of-the-art services, such as the provision of marine biological resources, via access to culture collections at Ghent University and University of Hasselt, sample collection facilities at Flanders Marine Institute (VLIZ), access to North Sea marine ecosystems, experimental facilities at Ghent University and VLIZ, omics and imaging technology platforms at KU Leuven and Ghent University. Ghent University coordinates the ERIC-wide activities for training and education via the MarineTraining platform (marinetraining.org) and the coordination of an international master programme (imbrsea.eu).

Impact and Importance

Through EMBRC, Flemish operators will continue to excel and strengthen their position in three areas:

1. Ocean warming, pollution and acidification have strong biological consequences. Therefore, understanding the ecological and evolutionary responses of marine organisms to a changing environment is crucial.
2. Many threatened marine organisms are important living resources used for food, but also for biotechnological applications. With a growing human population, more efficient and sustainable food

production and new technological applications are top priorities.

3. Given our increasing use of marine resources, one of our challenges is to develop new applications to measure ecosystem health, providing managers and policymakers with the support they need to ensure the sustainable development of the blue economy.



EMBRC-ERIC provides the necessary and relevant services, facilities and technology platforms to study marine organisms and ecosystems, promoting the development of blue bio-technologies.

FBI

Flanders BioImaging (FBI) - an integrated, translational and multimodal imaging platform from molecule to man.

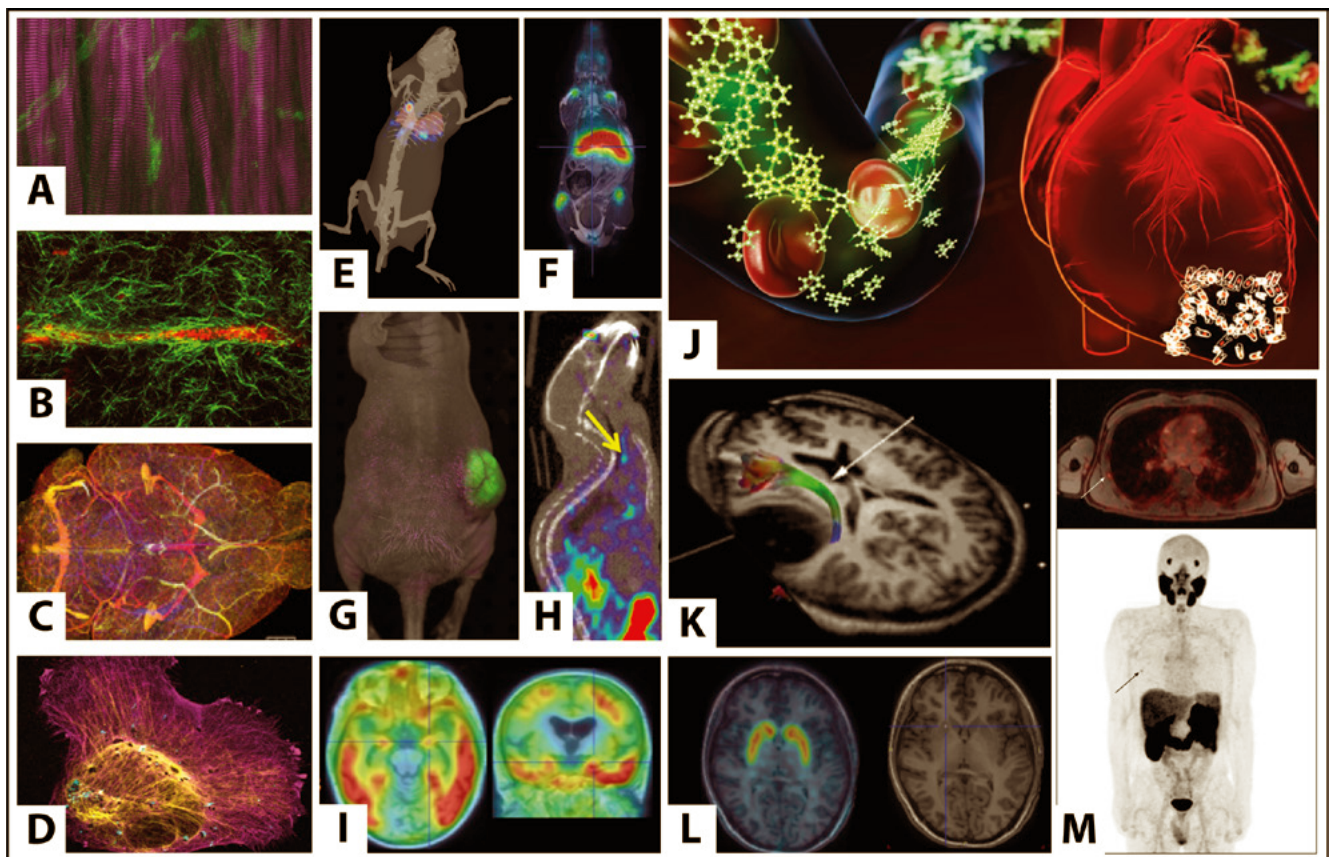

© FBI

Flanders BioImaging (FBI) is an inter-university consortium dedicated to biomedical imaging and advanced light microscopy. It was set up to integrate, optimize, rationalize and coordinate available imaging infrastructure in Flanders. The consortium was successfully evaluated

in the EU EuroBioImaging project (EuBI); EuroBioImaging achieved ERIC status in 2019. EuBI is also part of the EOSC-Life ESFRI cluster project (WP2) with the goal of developing cloud-based computational tools and workflows that process biomedical data.

FBI

IN FLANDERS ACTIVE SINCE

2019

FIND US ONLINE

- 📍 www.eurobioimaging-interim.eu/flamingo.html (biomedical imaging)
- 📍 www.eurobioimaging-interim.eu/limbo.html (microscopy)

GOOD TO KNOW

Multi-site node in Flanders/Belgium for the ERIC EuroBioImaging with continuous development of the latest imaging techniques and innovative probes in all domains of biotechnology and biomedical imaging. Belgium observer in EuroBioImaging-ERIC

CONSORTIUM

📍 **Coordinator Belgium**
Koen Van Laere
KU Leuven, Department of Imaging and Pathology
Nuclear Medicine and Molecular Imaging
koen.vanlaere@kuleuven.be
+32 16 34 37 15

- 📍 **Consortium members**
- **Chris Cawthorne**, coördinator, KU Leuven, christopher.cawthorne@kuleuven.be
 - **Sebastian Munck**, VIB, sebastianmunck@kuleuven.vib.be
 - **Winnok De Vos**, UAntwerpen, winnok.devos@uantwerpen.be
 - **Pieter Vanden Berghe**, KU Leuven, pieter.vandenbergh@kuleuven.be
 - **Jelle Hendrix**, UHasselt, jelle.hendrix@uhasselt.be
 - **Eric Achten**, UGent, rik.achten@ugent.be
 - **Tony Lahoutte**, VUB, tony.lahoutte@uzbrussel.be
 - **Kevin Braeckmans**, UGent, kevin.braeckmans@ugent.be
 - **Sigrid Stroobants**, UAntwerpen, sigrid.stroobants@uza.be

Activities, Equipment and Services

The imaging technologies and processing expertise offered include simultaneous (micro)PET-MR, (micro)PET-CT, (micro)SPECT-CT, (micro)MRI, (micro)CT, microUS, optical imaging, scanning and transmission electron microscopy, fluorescence-based optical tomography, high-throughput microscopy (e.g. for screening), deep tissue and whole organ(ism) micro-to mesoscopic imaging, as well as probe development infrastructure and expertise (radiopharmaceuticals, contrast agents, nanobodies, etc.).

Impact and Importance

A full and complementary portfolio of techniques and expertise is available within a 70 km radius of a central access point. In all domains, world-class, state-of-the-art equipment and innovative probes are available. The direct connection to university hospitals offers many opportunities for connecting preclinical with clinical research for high societal impact (neurodegeneration, oncology, cardiology, mental disorders, etc.). Imaging projects can be designed and executed from bench to bedside at one single location. EuBI/FBI seeks to harmonise and thus improve quality management for all imaging techniques.



Imaging allows the black box between genetics and human disease to be opened. It adds space and time coordinates to our omics knowledge.



NANOBODIES4INSTRUCT

Nanobodies for INSTRUCT

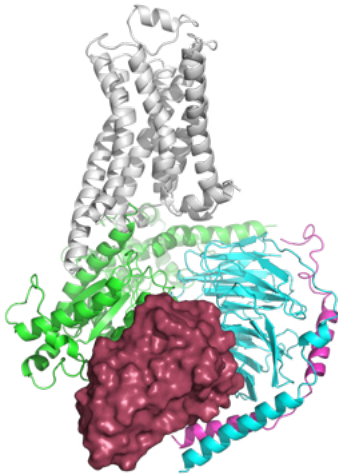

© NANOBODIES4INSTRUCT

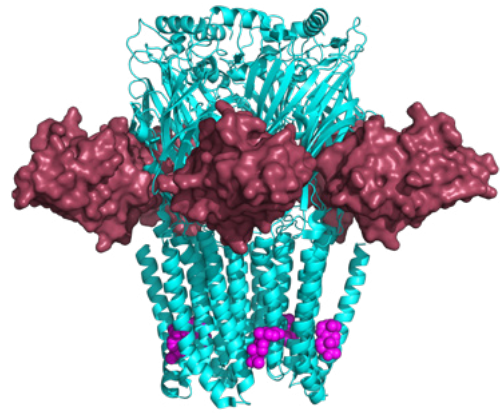

© NANOBODIES4INSTRUCT

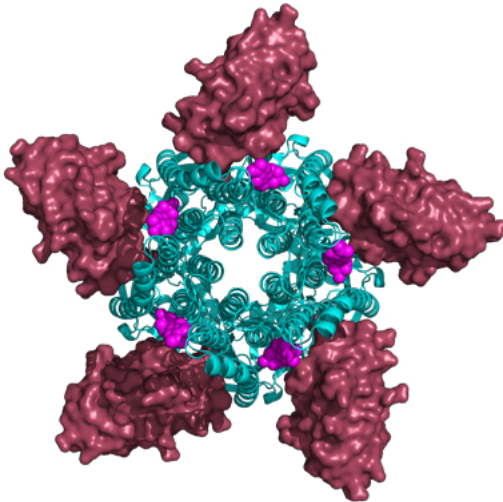

© NANOBODIES4INSTRUCT

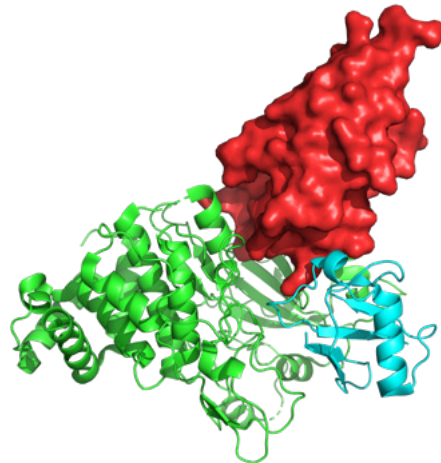

© NANOBODIES4INSTRUCT

Nanobodies4INSTRUCT

IN FLANDERS ACTIVE SINCE

2012

FIND US ONLINE

www.instruct-eric.eu/centre/nanobodies4instruct

[instructhub](#)

GOOD TO KNOW

Any scientist from an Instruct member state can submit a proposal for access to the Nanobodies4Instruct center for the discovery of conformational nanobodies and megabodies. This facilitates the structural analysis of proteins that are notoriously difficult to purify, crystallize or study by any other method. Since 2018, we have also offered megabodies to facilitate the structural characterization of proteins by single particle cryo-EM.

CONSORTIUM

 **Head of INSTRUCT Centre Belgium**
Jan Steyaert

VIB-VUB center for Structural Biology
jan.steyaert@vub.be
+32 495 27 02 48



The Nanobodies4Instruct center produces and characterises nanobodies to be used as auxiliary tools in structural and cellular biology. By learning more about the nature of each project, the team can advise in the design of antigens and work out optimal immunisation schemes, panning strategies and screening methods.

Activities, Equipment and Services

Nanobodies are the small (15 kDa) and stable single-domain fragments that harbor the full antigen-binding capacity of camelid heavy chain-only antibodies. Nanobodies are exquisite chaperones for crystallizing membrane proteins, multiprotein assemblies, transient conformational states and intrinsically disordered proteins. They can also be used for other applications in structural biology. Domain-specific nanobodies have been used in single-particle electron microscopy (EM) to track these domains in particle projections. Because nanobodies can be functionally expressed as intrabodies in eukaryotic cells, these single-domain antibodies can also be used to track their targets inside a living cell. Nanobodies are rigidly grafted into selected scaffold proteins to increase their molecular weight while retaining their full antigen-binding specificity.

Impact and Importance

Structural biology - solving 3D macromolecular structures with X-ray crystallography and cryo-EM - plays a key role in systems biology by adding molecular detail to these complex networks and cascades. However, many proteins tend to be flexible and therefore intractable for structure determination by any current method. Nanobodies4Instruct offers nanobodies as tools to freeze dynamic proteins into single functional conformations. X-ray crystallography and cryo-EM can then be used to determine the structures of different stills of the same moving biomolecule. Nanobodies discovered at the Steyaert lab were instrumental in solving the first active G protein coupled receptor (GPCR) structures frozen in the active state, locking membrane channels in open or closed states and for stabilizing transient complexes composed of more than one protein.

CMS

Compact Muon Solenoid experiment at the Large Hadron Collider at CERN

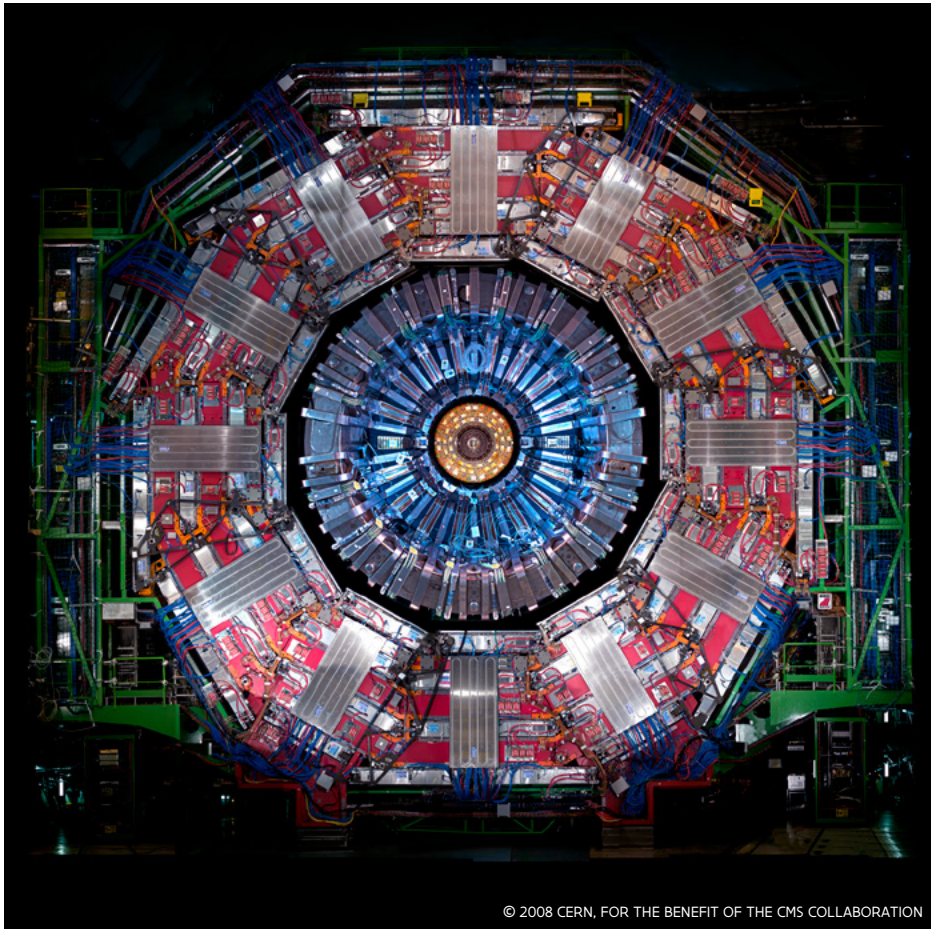

© 2008 CERN, FOR THE BENEFIT OF THE CMS COLLABORATION

The Large Hadron Collider (LHC) at CERN is the world's largest and most powerful particle collider. It is therefore the key focus point of the global research community aiming to unravel the secrets of fundamental physics. In its underground location near Geneva, the 27km circular track causes protons and heavy ions to collide at the highest energies achieved in any laboratory

to date. The Compact Muon Solenoid (CMS) experiment is one of two general purpose detectors recording and reconstructing the numerous particles created in the collisions. A worldwide computing network makes it possible to analyse the collisions. This is achieved through a global collaboration of about 230 knowledge institutions.

Activities, Equipment and Services

With a diameter of 15 metres and a length of 21 metres, the CMS detector is a cylindrical instrument with several dedicated concentric detector layers. Beams of high energetic protons collide in the centre of the device every 25 nanoseconds. In the resulting debris, the detector layers observe several hundreds of particles of various types with the aim of reconstructing their individual and collective properties. When all the parts of the puzzle are brought together, a complex image emerges for each collision. Facilitated by a vast, distributed computing network, these images are used for further analysis. The collaborating organizations are responsible for the construction, operation, maintenance and upgrade of the detector, the computing network and the software framework.

Impact and Importance

Our research is driven by innovations in technology and computing that make it possible to see the smallest particles that are otherwise invisible. The societal benefits of these innovations are numerous. For example, the same technology is used to make it possible to see otherwise invisible aspects on the scales of humans, especially related to health, energy and safety. The scientific impact is unique and groundbreaking, as illustrated by the large number of publications and their impact. The discovery of the Higgs particle, leading to the Nobel Prize for F. Englert, is a clear highlight. These are also unique training grounds for early career researchers seeking innovation in technology and data analysis.



The particle collider and its detectors allow us to zoom in on the most fundamental structures of the matter around us and to make visible what is otherwise invisible to our eyes.

CMS

IN FLANDERS ACTIVE SINCE

2016 upgrade

FIND US ONLINE

 cms.cern

 CMSEXperiment

GOOD TO KNOW

First particle collisions at the LHC (2009);
discovery of the Higgs particle (2012);
first collisions at 13 TeV (2015).

CONSORTIUM

Coordinator of the Flemish consortium **Jorgen D'Hondt**

Vrije Universiteit Brussel
Interuniversity Institute for High Energies (IIHE)
jodhondt@vub.ac.be
+32 496 70 48 65

Consortium members

- **Pierre Van Mechelen**,
University of Antwerp,
pierre.vanmechelen@uantwerpen.be
- **Michael Tytgat**, Ghent University,
michael.tytgat@UGent.be
- **Paul Leroux** (associate member),
Katholieke Universiteit Leuven (Geel),
paul.leroux@kuleuven.be
- **Pascal Vanlaer**, Université Libre de
Bruxelles, pvanlaer@ulb.ac.be
- **Christophe Delaere**,
Université Catholique de Louvain,
christophe.delaere@uclouvain.be



ESRF (EBS), DUBBLE

European Synchrotron Radiation Facility (Extremely Brilliant Source), Dutch-Belgian Beamline

A single-sited infrastructure in Grenoble, France, the ESRF is the world's most intense synchrotron X-ray source. It investigates the structure and function of atoms, molecules and materials. Via peer reviewing, project proposals to use the ESRF X-ray beam stations (beam lines) are ranked and beam time is given to a country in

proportion to its membership fee. ESRF members are also allowed to construct and exploit so-called CRG (Collaborating Research Group) beam lines at the ESRF. DUBBLE is one such CRG beamline. It provides priority access to the synchrotron facility for Flemish and Dutch users.

Activities, Equipment and Services
Synchrotron X-ray sources are up to 15 orders of magnitude more brilliant than laboratory sources. Unlike laboratory sources, they have a tunable wavelength. From the interaction of synchrotron X-ray beams with matter, one can deduce the structure, chemical state and composition of substances



ESRF (EBS), DUBBLE

IN FLANDERS ACTIVE SINCE

1995

FIND US ONLINE

www.esrf.eu/UsersAndScience/Experiments/CRG/BM26

www.esrf.eu/UsersAndScience/Publications/Newsletter

GOOD TO KNOW

Belgium was involved from the very beginning in 1988, when, together with 10 other European countries, an agreement was signed to build and exploit the ESRF.

CONSORTIUM

Coordinator of the Flemish consortium Bart Goderis

KU Leuven
Polymer Chemistry and Materials
bart.goderis@kuleuven.be
+32 16 32 78 06

Consortium members

- **Laszlo Vincze**, Universiteit Gent, Laszlo.Vincze@UGent.be
- **Koen Janssens**, Universiteit Antwerpen, koen.janssens@uantwerpen.be
- **Marlies K. Van Bael**, UHasselt, marlies.vanbael@uhasselt.be
- **Herman Terryn**, Vrije Universiteit Brussel, Herman.Terryn@vub.ac.be
- **Sean McMichell**, imec, Sean.McMitchell@imec.be
- **Ruben Snellings**, VITO, ruben.snellings@vito.be



in operando and in situ at atomic to macroscopic length, and timescales ranging from femtoseconds to hours. DUBBLE is composed of two beam lines: one for combined small (SAXS) and wide angle (WAXS) scattering and one for X-Ray spectroscopy (XAS, EXAFS and XANES) and imaging. Under a beam time exchange agreement between DUBBLE and the Swiss-Norwegian CRG it is possible for Dutch and Flemish researchers to use the Swiss-Norwegian powder diffraction facilities.

Impact and Importance

The exploration of matter at a synchrotron source allows scientists and engineers to design new sustainable materials, innovative industrial products, advanced electronic components or better solar cells. Such studies also reveal what our planet is made of, what the processes are that sustain life or what secrets are hidden behind old paintings. Other users aim to develop tastier and healthier food, or to find new ways of conquering diseases. At the ESRF and DUBBLE, fundamental as well as applied research is conducted, enabling the transformation of knowledge into economic and societal value.



The DUBBLE Beam Lines at the ESRF: Extremely brilliant X-rays for revealing the structure and function of atoms, molecules and materials.

ET

Einstein Telescope, European gravitational wave observatory

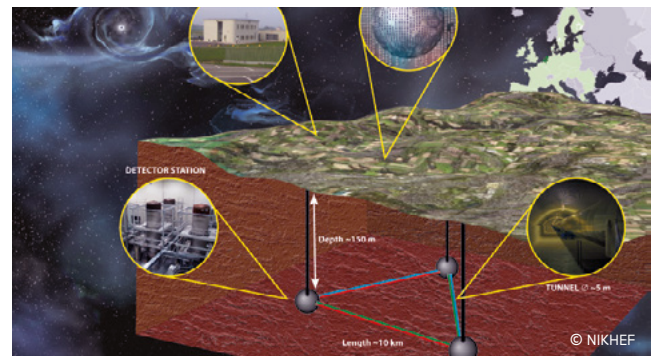
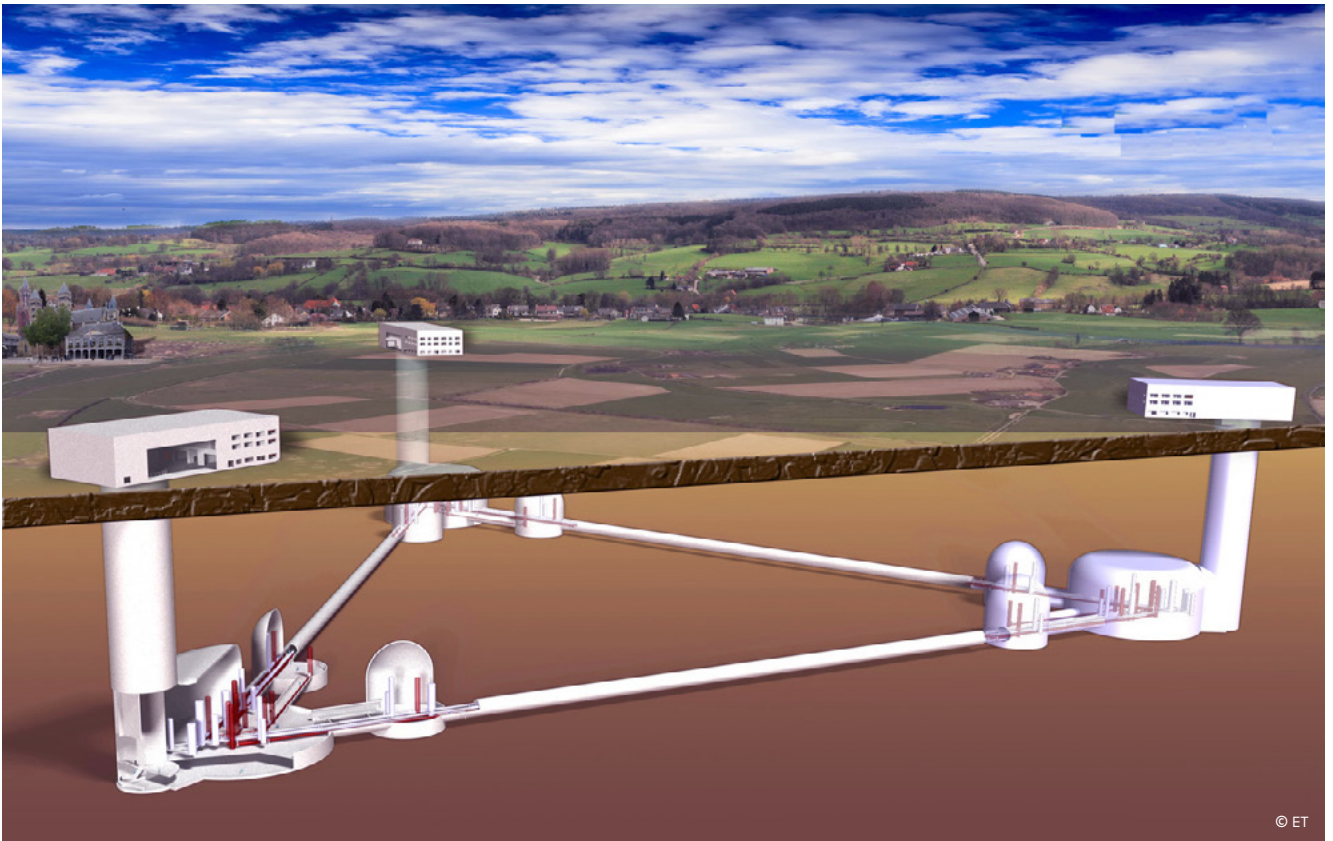

ET

IN FLANDERS ACTIVE SINCE

New project

FIND US ONLINE

www.fys.kuleuven.be/gwc/

www.et-gw.eu

GOOD TO KNOW

An ESFRI application is currently being prepared.

CONSORTIUM

Coordinator of the Flemish consortium

Thomas Hertog

KU Leuven

Gravitational Wave Center/
High-energy Physics

Thomas.hertog@kuleuven.be

+32 16 32 72 46

Consortium members

- **Nick Van Remortel**, University of Antwerp, nick.vanremortel@uantwerpen.be
- **Dirk Ryckbosch**, Ghent University, Dirk.Ryckbosch@ugent.be
- **Alexander Sevrin**, Free University of Brussels, Alexandre.Sevrin@vub.ac.be
- **Milos Nesladek**, University of Hasselt, milos.nesladek@uhasselt.be
- **Christophe Collette**, Université Libre de Bruxelles, ccollett@ulb.ac.be
- **Giacomo Bruno**, University of Louvain, giacomo.bruno@uclouvain.be
- **Frederic Nguyen**, University of Liège, f.nguyen@uliege.be



Einstein Telescope is Europe's future advanced gravitational-wave observatory. Envisaged as the pioneering node of a global 'third-generation' network of gravitational-wave observatories it is designed to detect gravitational waves reaching Earth from the entire observable universe. As such, it will open up hitherto unexplored 'dark' regions of the universe. This includes the early stages after the Big Bang and the close environment of black holes. Einstein Telescope is likely to be single-sited. The Meuse-Rhine region in the Belgian-Dutch-German border area is one of two prime candidate areas for the Einstein Telescope site. All Flemish universities are currently involved in instrumentation or scientific studies to prepare the ground for Einstein Telescope.

Activities, Equipment and Services

Einstein Telescope is a multi-interferometer observatory covering the entire spectrum of gravitational waves observable with Earth-based facilities. ET consists of an underground triangular configuration, with an interferometer arm-length of around 10 kilometers, and will be operational as a research facility for several decades. The advanced technologies needed for the construction and operation of ET, including lasers, sensors, optics, seismic isolation, materials and data analysis technology, will have a profound impact on several industrial sectors.

Impact and Importance

As the first and most advanced 3rd generation gravitational wave observatory, ET will put Europe at the forefront of this emergent field of research. ET will also enable Europe to take the lead in the multi-messenger astronomy that combines gravitational, electromagnetic and neutrino observations. If Einstein Telescope were to be sited in the Meuse-Rhine region, our area will become a global hotspot for gravitational-wave science and engineering throughout the 21st century. Beyond this, Einstein Telescope will function as a magnet bringing different players together in a stimulating ecosystem where creative and innovative research, entrepreneurship and unique educational opportunities reinforce each other and thrive.



Colliding black holes
to trigger
innovation in
Flanders.

GANIL SPIRAL2

Grand Accélérateur National d'Ions Lourds - Système de production d'Ions Radioactifs en Ligne de 2ème génération



The SPIRAL (1 and 2) projects at GANIL (France) aim to produce unique radioactive ion beams for fundamental and applied studies in the fields of nuclear-, atomic-, astro- and fundamental interaction physics. For SPIRAL2, a new and unique superconducting linear accelerator, capable of accelerating 1 mA heavy ions up to 14.5 MeV/u, is being commissioned. The "Super Spectrometer Separator - S3" coupled to the accelerator will provide pure beams of short-lived medium-heavy and heavy exotic isotopes for laser spectroscopic studies. SPIRAL1 is being upgraded to produce more intense radioactive ion

beams of lighter nuclei for reaction studies and fundamental interaction studies performed using dedicated ion manipulation and detection systems. It is a single site facility that is used by Flemish groups to develop international collaboration programmes to study strong and weak interactions in atomic nuclei.

Activities, Equipment and Services

The SPIRAL facility at GANIL will offer radioactive ion beams not available elsewhere, with large intensities and energy levels up to tens of MeV/u. These radioactive ion beams will be produced using, among others, the Super Separator Spectrometer (S3) that is coupled to the new SPIRAL2 heavy ion linear accelerator. These beams include the heaviest beams in the Mendeleev table. The upgraded SPIRAL1 project will deliver radioactive ion beams of light nuclei that will be used for reaction studies using the ACTAR Time Projection Chamber detector and for fundamental

studies using the PILGRIM Time of Flight setup.

Impact and Importance

The facility supplies unique radioactive ion beams that will be used by Flemish research groups to:

- study the heaviest elements in the Mendeleev table through a novel laser spectroscopy that was developed at KU Leuven;
- induce secondary nuclear reactions in an active target configuration, allowing the detection of the reaction products and emitted radiation with unprecedented sensitivity;
- focus on fundamental interaction studies using the dedicated MORA setup currently under development.

These unique studies will reveal hidden aspects of the strong and weak interactions in atomic nuclei. These studies pave the road for fundamental studies currently under consideration at the MYRRHA facility (SCK-CEN, Belgium).

GANIL SPIRAL2

IN FLANDERS ACTIVE SINCE

2013

FIND US ONLINE

www.ganil-spiral2.eu

GOOD TO KNOW

Piet Van Duppen is the scientific coordinator of the S3 Low-Energy Branch (S3 LEB), a member of the Comité de Pilotage du projet S3 (the S3 steering committee) and chairs the S3 LEB management board. He is also a member of the S3 User Collaboration Council.

CONSORTIUM

Coordinator of the Flemish consortium

Piet Van Duppen

KU Leuven

Nuclear Spectroscopy Group

piet.vanduppen@kuleuven.be

+32 16 32 72 72

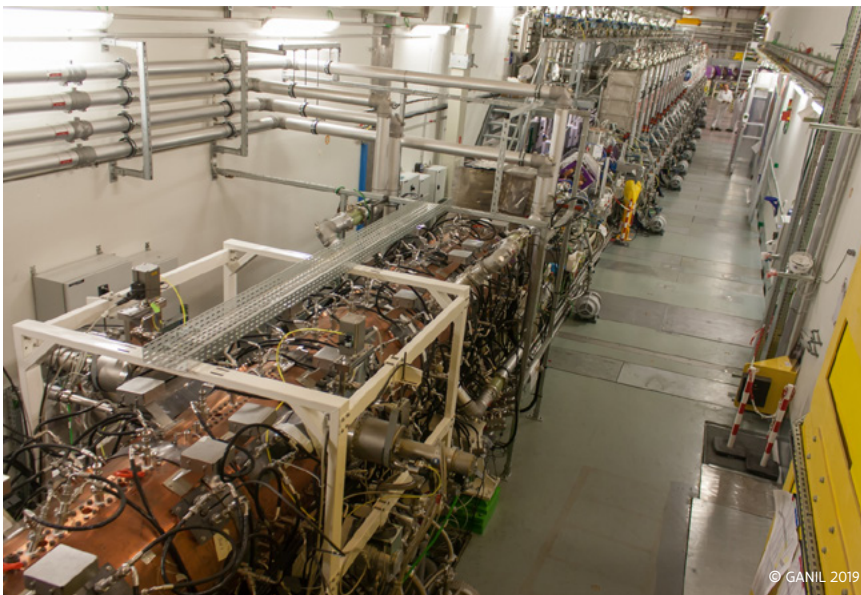

ICECUBE

The IceCube Neutrino Observatory
at the South Pole

The IceCube observatory is located close to the geographic South Pole and comprises a surface detector (Icetop) for cosmic ray studies, and about 5200 sensors buried in the deep glacial ice at depths between 1450m and 2450m. There is a total of 1 cubic kilometer of instrumented ice dedicated to detecting high-energy neutrinos. The Flemish research teams play a key role in the study of cosmic ray composition and the search for high-energy neutrinos related to explosive cosmic phenomena. After the discovery of high-energy neutrinos in 2013, it became clear that an extension of the observatory was needed to

obtain sufficient data at higher neutrino energies. This will be achieved by the development of an array of radio detector stations, in which the Flemish teams have taken the lead.

Activities, Equipment and Services

The Flemish groups are key players in various IceCube analysis areas and play a part in the detector operations, data verification, equipment maintenance and management within the international IceCube consortium. The computer cluster in Brussels is one of the principal facilities for collaboration-wide use. Furthermore, Flanders has been a significant contributor to

the creation of the IceCube neutrino observatory at the South Pole. Flemish teams were instrumental in the commissioning of the detector. For the extension to higher energies, Flemish team members have taken a lead in detector R&D, lowering the energy threshold for radio detection techniques. For the new radio array, the Flemish consortium will play a similar role to the one outlined above.

IceCube

IN FLANDERS ACTIVE SINCE

2003

FIND US ONLINE

www.iihe.ac.be/icecube

www.icecube.wisc.edu

www.icecube.wisc.edu/news

GOOD TO KNOW

Plans include an extension of the observatory to include both lower and higher neutrino energies. The Flemish participation focuses on the high-energy extension, dubbed IceCube-Gen2, that will use radio detection techniques.

CONSORTIUM

Coordinator of the Flemish consortium

Nick van Eijndhoven

Vrije Universiteit Brussel (VUB)
Astroparticle Physics (IIHE-VUB)
Nick.van.Eijndhoven@vub.be
+32 2 629 32 03

Consortium members

- **Dirk Ryckbosch**, Ghent University, Dept. of Physics and Astronomy
- **Stijn Buitink**, Vrije Universiteit Brussel (VUB), Astrophysics research group
- **Juan Antonio Aguilar**, Université Libre de Bruxelles (ULB), Dept. of Physics and Astronomy



Impact and Importance

The discoveries of cosmic rays, extraterrestrial high-energy neutrinos and gravitational waves have had an enormous impact on the field of astrophysics and cosmology. They have opened up completely new areas of study of the universe, revealing parts not accessible by other messengers. As such, this “new astronomy” is poised to yield new surprises and unexpected discoveries. The situation is probably best compared to the advent of radio astronomy, which also revealed a large range of new phenomena.

The origins of cosmic rays and neutrinos remains unknown. The search for the mysterious sources of these “ghost particles” represents an exciting scientific adventure that will provide insight into the inner engines of the most powerful and possibly least understood phenomena in the universe. The above provides ample opportunities to convey the results of this research to a large audience. Since humankind has always been fascinated by the universe, this will appeal to experts and laymen alike. Especially in view of the fact that we are detecting “ghost particles” with a gigantic detector located at a very exotic location, deep in the ice at the South Pole! This attraction became very clear at “90 degrees South”, a large outreach event for primary and high-school students held at the VUB campus.

Outreach can be achieved via scientific talks, public lectures, expositions (e.g. at planetaria) and the use of modern social media. Various team members are regularly involved in these activities. We also would like to mention that in Brussels, we have composed an educational multi-language video for the broad public. In layman’s terms, it explains the principle of investigating transient cosmic events using the IceCube neutrino observatory at the South Pole. This video can be found at <https://sites.google.com/site/nickveweb/Home/lectures/icecubemasterclass>.



IceCube has opened a new window on the universe that is being regarded as the Birth of Neutrino Astronomy.

ISOLDE

The ISOLDE Radioactive Ion Beam facility at CERN

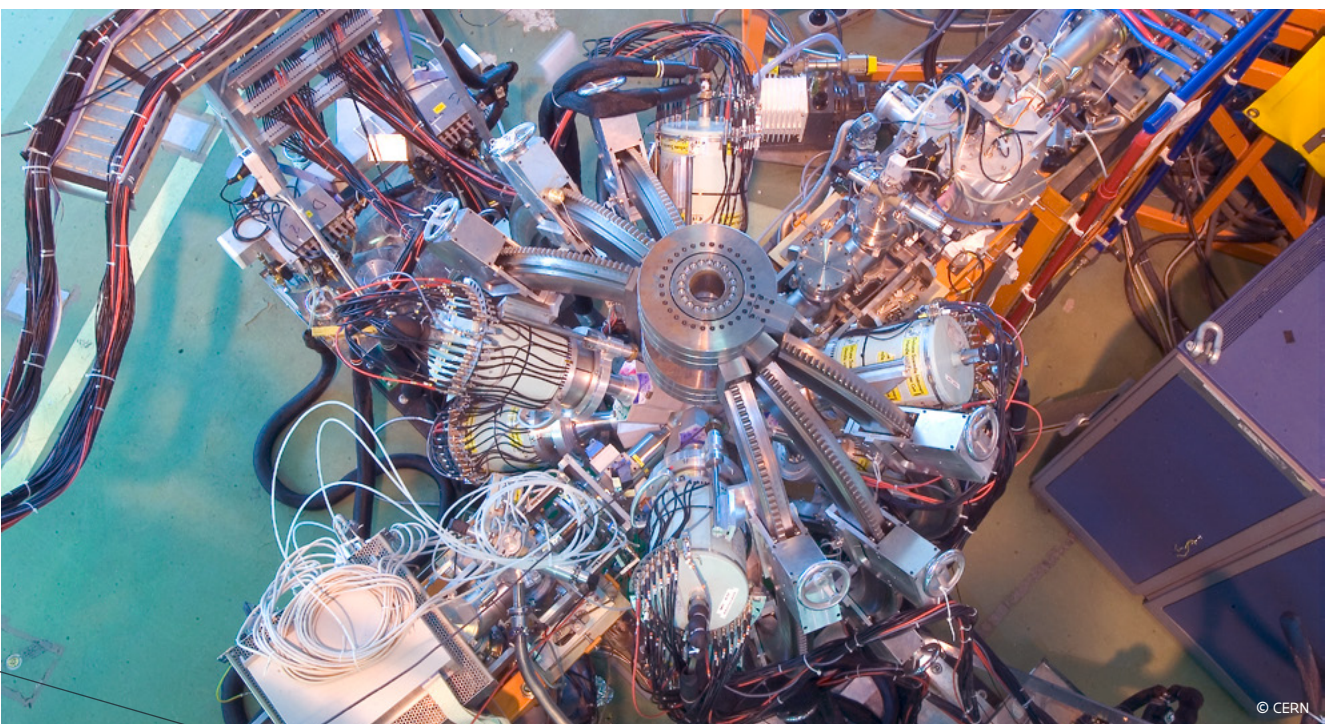
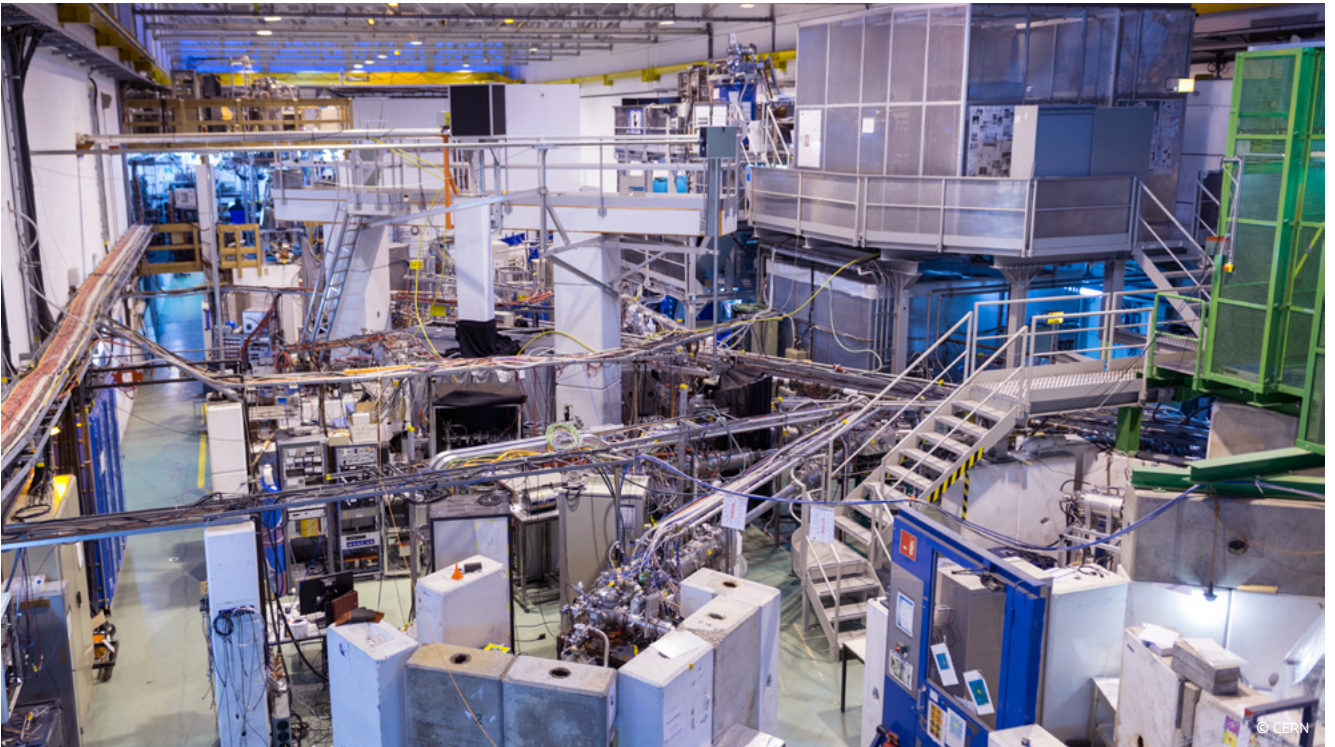

ISOLDE

IN FLANDERS ACTIVE SINCE

1993

FIND US ONLINE

isolde.web.cern.ch

GOOD TO KNOW

EPIC – Exploiting the Potential of ISOLDE at CERN

CONSORTIUM

 **Coordinator of the Flemish consortium**
Riccardo Raabe
Institute for Nuclear and Radiation Physics,
KU Leuven
riccardo.raabe@kuleuven.be
+32 16 32 72 73

ISOLDE, situated at CERN, is a world-class laboratory for the production and study of radioactive nuclei. These nuclei are produced by collisions of the proton beam from the CERN Proton- Synchrotron Booster with thick targets. ISOLDE has the widest range of radioactive ion beams available worldwide, in a wide range of energies ranging from a few keV up to 10 MeV/nucleon. Flemish groups are active at ISOLDE and other radioactive ion beam facilities including SPIRAL/GANIL to perform fundamental and applied research.

Activities, Equipment and Services

At ISOLDE, the proton beam of CERN is directed at a target material to produce all sorts of rare nuclei in high-energy collisions. These nuclei are then selected and guided to experimental stations. Flemish research groups use state-of-the art detection equipment and a wide range of methods and the radiation from the nuclei as probes. They study the fundamental laws that govern the properties of matter at the femto- and nanoscale, investigating the characteristics of novel materials for technological advances, and exploring societal applications, such as the use of new radioisotopes for medical purposes.

Impact and Importance

Through an understanding of the properties of nuclear matter, one can shed light on key questions at very different scales: what is the origin of all chemical elements? Is there an end to the periodic table? What is the destiny of massive celestial objects? Etc. The investigation of novel materials and structures at the nanoscale can respond, at a fundamental level, to pressing issues driven by technological applications. Properties of novel radioisotopes can be beneficial to society at large: for example, the medical use of the same isotope in both diagnostics (i.e. imaging) and therapy procedures.



At ISOLDE, we push technological boundaries to study the infinitely small and thus understand and improve the world we live in.



METIS

METIS at the E-ELT:
development and exploitation
of innovative ground-based
astronomical instrumentation.

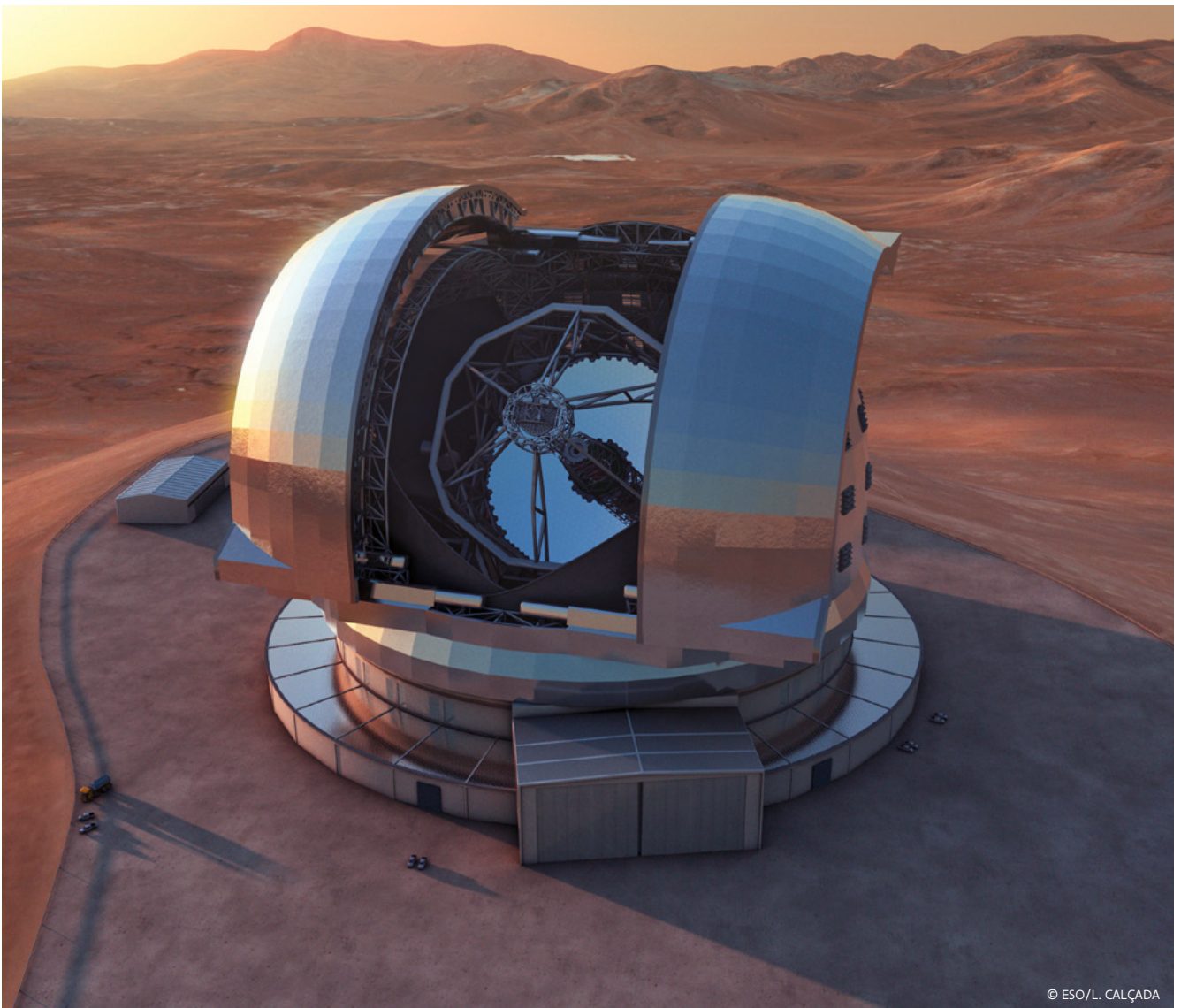

Belgium is a founding member of the European Southern Observatory (ESO), the pre-eminent European intergovernmental science and technology organization in astronomy. ESO is in the process of building the largest ground-based telescope: the 39m ELT. METIS will be one of the measuring instruments of the telescope. METIS will be built by an international consortium of nine European astronomy organisations, each represented at co-investigator level. It is founded on the technological leadership we developed at the Flemish Mercator telescope.

Activities, Equipment and Services

METIS is a versatile mid-infrared instrument for the ELT. The design and procurement of an instrument this complex takes several years of research and development. The Flemish funds allow us to perform work packages under our responsibilities within the consortium. In acknowledgement of our experience with the Flemish Mercator telescope, we have been made responsible for the global control system of the instrument.

This includes the general electrical and control design, electronics and control software. We also provide the system lead for the control software and contribute to the data analysis pipeline, as well as the definition of the top-level control scripts for calibration and observation templates. We will lead the scientific return for several key scientific questions on the basis of which the instrument was developed.

Impact and Importance

Modern observational astrophysical research is technology-driven: new observational facilities create new opportunities to steer and expand our physical understanding of the universe and its components. The ELT will be the next giant step in four centuries of astrophysical research using telescopes. Technological know-how and experience are hence closely linked to the astrophysical exploitation of the infrastructure.



From Mercator to METIS: Flanders is at the forefront of astrophysical instrumentation projects and helps to build the most sensitive infrared instrument of the large European telescope ELT.

METIS

IN FLANDERS ACTIVE SINCE

2009

FIND US ONLINE

www.fys.kuleuven.be/ster/instruments/elt-metis

metis.strw.leidenuniv.nl

[elt_metis](https://twitter.com/elt_metis)

GOOD TO KNOW

METIS is a measuring instrument for the ELT, currently under construction at the European Southern Observatory (ESO). The ELT will have first light in 2025. METIS will be delivered to the telescope in 2026.

CONSORTIUM

 **Coordinator of the Flemish consortium**

Hans Van Winckel

Institute of Astronomy, Department of Physics and Astronomy KU Leuven

Hans.VanWinckel@kuleuven.be

+32 16 32 70 32



DARIAH-BE

Open Humanities Service Infrastructure



DARIAH: unlocking
the scientific
potential of digital
research in
the humanities.

DARIAH-BE

IN FLANDERS ACTIVE SINCE

2014

FIND US ONLINE

- 🌐 be.dariah.eu
- 🌐 be.dariah.eu/news/open-humanities-gets-infrastructure-boost-flanders
- 🌐 www.dariah.eu
- 🐦 [dariahbe](https://twitter.com/dariahbe)
- ✉ lists.ugent.be/www/info/dariah-be

CONSORTIUM

📍 **DARIAH-BE Belgian Coordinator**
Christophe Verbruggen
Ghent University
Ghent Centre for Digital Humanities
Christophe.Verbruggen@UGent.be
+32 9 331 02 76

📍 Consortium members

- **Dirk Van Hulle**, University of Antwerp, dirk.vanhulle@uantwerpen.be
- **Mark Depauw**, KU Leuven, mark.depauw@kuleuven.be
- **Wouter Ryckbosch**, Free University of Brussels, Wouter.Ryckbosch@vub.be
- **Johan Van Der Eycken**, State Archives of Belgium, johan.vandereycken@arch.be
- **Frédéric Lemmers**, Royal Library of Belgium (KBR), frederic.lemmers@kbr.be
- **Paul Bertrand Catholic**, University of Louvain, bertrand@uclouvain.be
- **Björn-Olav Dozo**, University of Liège, bo.dozo@ulg.ac.be

DARIAH is a pan-European distributed infrastructure for Arts and Humanities researchers working with computational methods. DARIAH was included in the first Roadmap of the European Strategy Forum on Research Infrastructure (ESFRI) in 2006, and has been established as a European Research Infrastructure Consortium (ERIC) since 2014. Currently, DARIAH has 19 members and many cooperating partner institutions across 8 non-member countries.

Belgium is a Founding Member of DARIAH. The Flemish contribution to DARIAH in close cooperation with 'CLARIAH-VL Open Humanities Service Infrastructure', offering a sustainable portfolio of services that enable digital scholarships in the Arts and Humanities in Flanders, Belgium and beyond.

Activities, Equipment and Services

DARIAH is a research infrastructure for exchanging and sustaining tools, services, data and knowledge from its member countries. It will enable Arts and Humanities researchers to contribute to the European Open Science Cloud. Offering an open infrastructure which facilitates public humanities is a guiding principle. Flemish contributions to DARIAH include: i) an IIF-enabled tool suite for

building and annotating a research corpus and exporting the textual data for analysis with digital research tools; ii) a participatory deep-mapping platform to facilitate crowdsourcing for a rich array of geo-spatially annotated resources; iii) a web-based platform for the publication of digital scholarly editions; and iv) a Linked Open Data infrastructure for analysing, sharing, connecting and enriching Arts and Humanities research data.

Impact and Importance

DARIAH exists to enable excellent research in Arts and Humanities by facilitating a wide uptake of digital methods. The inherent value of ESFRI Research Infrastructures is that they are long-term, sustainable and state-of-the-art.

Through participation in DARIAH, the potential for the long-term sustainability of the results of digital research (data, tools, software, knowledge) after the end of short-term project funding is substantially increased. Membership in DARIAH improves access to (European) funding opportunities, allowing infrastructure to continue to innovate, therefore increasing the potential for achieving significant scientific breakthroughs.



ESS

European Social Survey - Belgium



© ARTHIMEDES / SHUTTERSTOCK.COM

The European Social Survey is a biennial, academically-driven social survey designed to chart and explain the attitudes, beliefs and behaviour of its diverse populations. The UK is the coordinating country, and the ESS ERIC Headquarters is located at City University, London. The headquarters is supported in the design and

implementation of the ESS ERIC Work Programme by six other institutions in different European countries that collectively comprise the ESS ERIC Core Scientific Team. Countries affiliated with ESS ERIC are divided into three categories: members, observers and guests. Belgium has been a member since the establishment of the ESS ERIC.

Activities, Equipment and Services

The ESS is creating an international database about social and political attitudes. It covers topics such as immigration, well-being, citizen involvement, justice, and climate change. The complete ESS database is freely available for the academic community, policymakers and interested citizens. The ESS database offers academics ample opportunities to interpret how Europe's social, political and moral fabric is changing. The infrastructure provides indications of national progress, based on citizens' perceptions and judgements of key aspects of their societies. These indications are of high relevance for policymakers and the wider public. The ESS contributes to improving the standards of rigour in cross-national research and the training of social researchers in quantitative analysis.

Impact and Importance

Since its start in 2001, the ESS has had a wide impact in the academic world and beyond. By 2017, over 2,700 academic papers using ESS data had been published. The infrastructure has over 100,000 registered data users. In addition to its academic impact, the ESS is frequently used as a data source for methodological and statistical courses across Europe in recognition of its high quality standards. The continued participation of Flanders in the ESS stimulates substantive comparative research on Flemish/Belgian citizens' attitudes in relation to other European populations and improves the expertise in survey analysis in Flanders.



Collecting
high-quality survey
data to study
citizens' attitudes
and behavior in a
changing Europe.

ESS

IN FLANDERS ACTIVE SINCE

1998

FIND US ONLINE

www.europeansocialsurvey.org/about/country/belgium/dutch/ess_belgium.html
www.europeansocialsurvey.org

GOOD TO KNOW

Belgium participated from the first round of data collection in 2002.

In 1998, Jaak Billiet was part of the ESS committee that drafted the blueprint for the European Social Survey.

CONSORTIUM

 **National Coordinator of ESS – Belgium/ Flanders**

Bart Meuleman

KU Leuven

Centre for Sociological Research (CeSO)

bart.meuleman@kuleuven.be

+32 16 32 31 31

 **Consortium members**

- **Patrick Italiano**, Centre d'Etude de l'Opinion, University of Liège



SHARE

SHARE: Survey of Health, Ageing and Retirement in Europe (Flanders)

SHARE is a distributed infrastructure that gives access to extensive micro-level data from more than 140,000 individuals from 27 European countries, and Israel. SHARE's strengths lie in the breadth of its coverage, its survey design and its innovative methodologies. First, no other data set in Europe provides such a specialised or broad scope of information on ageing. Second, SHARE offers harmonised and representative panel data. And third, SHARE explores and implements novel survey methods and questions. The infrastructure enables high-quality research on the Flemish level and the Belgian level, as well as reliable cross-country comparative research.

Activities, Equipment and Services

Ageing is a key societal challenge. The goal of the ESFRI project SHARE is to build a distributed infrastructure to collect a data set that offers researchers and policymakers a state-of-the-art instrument for the detailed and multidisciplinary study of ageing and the challenges it poses. The SHARE data set is a unique ex-ante harmonised data set of cross-national, comparable

microlevel panel data on health, living conditions, socioeconomic status, and social networks of more than 140,000 European individuals aged 50 and over, from 28 countries. The data set has become a pivotal source for empirical academic research on ageing in Europe in many disciplines, such as economics, health studies, sociology, and demography.

Impact and Importance

The "Vlaanderen In Actie, Pact 2020" explicitly mentions ageing as a key societal challenge for Flanders. The data set SHARE provides highly valuable input for addressing this societal challenge in an integrated and evidence-based way. The SHARE consortium currently collaborates with various Belgian policymakers. SHARE data is also used to guide policy decisions at the European level and in several European countries. Moreover, the EU commission uses the data for economic and social benchmarking exercises as part of the European Semester. Finally, SHARE data is also used by international organisations like the OECD, WHO and the World Bank.





© SHUTTERSTOCK



SHARE

IN FLANDERS ACTIVE SINCE

2004

FIND US ONLINE

www.share-project.be
www.share-eric.eu

[@SHARE_MEA](https://twitter.com/SHARE_MEA)

www.share-blog.eu

www.share-project.org/press-news/newsletter.html

GOOD TO KNOW

As of April 2019, seven waves of data were available for research purposes, free of charge. Currently, the eighth wave of data is being collected. Novelties in this wave are additional questions and tests related to cognitive functioning; an objective measurement of activity levels (accelerometry); and two sets of questions regarding time expenditure and savings behaviour.

CONSORTIUM

Coordinator of the Flemish consortium
Koen Decancq
University of Antwerp
Centre for Social Policy Herman Deleeck
koen.decancq@uantwerpen.be
+32 3 265 53 83

Consortium members

- **Dimitri Mortelmans**, University of Antwerp, Centrum voor Demografie, Familie en Gezondheid
- **Bea Cantillon**, University of Antwerp, Centre for Social Policy Herman Deleeck
- **Sergio Perelman**, University of Liège, department of Economics

VSC-EUROHPC

Brings together knowhow in scientific and technical computing in Flanders

VSC encourages the use of scientific and technical computing in the Flemish academic and industrial landscape. To this end, it offers infrastructure, training and services. In addition, VSC acts as a lever to promote HPC (high-performance computing) and its added value to society. The VSC engages and actively participates in international initiatives such as EuroHPC and PRACE.

EuroHPC represents a unique opportunity for Europe to step forward and reap the benefits of mastering advanced digital technologies that rely on supercomputing. The convergence and combination of HPC with other technologies such as big data, the cloud, and artificial intelligence is a catalyst for the fourth industrial revolution, and a key element of the European road to digitization.

Activities, Equipment and Service VSC

VSC offer its target audience access to diversified ICT infrastructure that is tailored to the needs of scientific/technical computing. VSC provides therefore a common user environment on the computing infrastructure, which is available in the 4 local hubs. Users are supported so that they can lift their research and development to a higher level. VSC also informs about the capabilities and achievements of HPC and its potential added value by i.e. actively promoting scientific/technical computing in Flemish industry and fostering the exchange of ideas and expertise between research institutions and industry. A diverse and coordinated training programme is offered across the VSC consortium to stimulate and advance the uptake of scientific/

technical computing in new and existing users.

EuroHPC

VSC is an active partner in the LUMI consortium. It also prepared a proposal to set up, within the EuroHPC framework, a national competence center on HPC, together with other parties in Belgium.

The EuroHPC work programme is focused on the infrastructure development on a path to exascale computing and beyond, the associated software and service and even more important the rapid development of the HPC skill base across Europe. Within the infrastructure development activities, the realization of a European lower power processor is of critical strategic importance with the ambition





of building an exascale supercomputer based on the European processor.

In 2019 EuroHPC selected the hosting sites for 3 pre-exascale and 5 petascale machines and started the procurement process aiming at operational machines in Q1-2021. These machines will serve both public and private users throughout Europe to developing leading scientific and industrial applications.

Belgium has a considerable stake in the LUMI consortium which will host and exploit one of the three EuroHPC pre-exascale infrastructures. This consortium is under the lead of Finland and brings the expertise of Belgium, Czech Republic, Denmark, Estonia, Norway, Poland, Sweden and Switzerland together.

Impact and Importance

Benefits for citizens

The supercomputing ecosystem is a critical infrastructure for understanding and responding to complex challenges like simulations to reduce the environmental footprint of industry and society at large, or predicting the impact of severe weather conditions.

Benefits for industry

The supercomputing ecosystem acts a lever for increasing productivity and the scale-up to higher value products and services, significantly reducing time to market by faster design

and production cycles, accelerating the design and discovery of new materials, cost reduction, increasing resource efficiency and shortening and optimizing decision processes.

Benefits for science

The supercomputing ecosystem will be at the heart of the digital transformation of science. It enables leading-edge research to answer fundamental science questions and make new discoveries and breakthroughs. Today, more than 700 scientific applications depend on HPC.

Supercomputing and Big Data analysis provide scientists with deeper insights into previously unexplored areas and systems of the highest complexity, driving the innovation and discovery of almost all scientific disciplines. Large-scale scientific challenges that HPC help to address include decoding the functioning of the human brain, discovering new drugs or predicting the development...



VSC-EuroHPC

IN FLANDERS ACTIVE SINCE

2008

FIND US ONLINE

www.vscentrum.be

[EuroHPC: eurohpc-ju.europa.eu](http://EuroHPC.eu)

www.linkedin.com/company/vschpc/

www.linkedin.com/company/eurohpc-ju/

GOOD TO KNOW

High-performance computing is ‘the’ tool to create positive impact.

Some examples are: reducing the environmental footprint, predicting the impact of severe weather conditions, enabling traditional sectors to become more productive and to scale up to higher value products and services, enabling leading-edge research to answer fundamental science questions and make new discoveries and breakthroughs.

CONSORTIUM

VSC is a partnership between the five Flemish universities and their university associations:

Associatie Universiteit & Hogescholen Antwerpen, Universitaire Associatie Brussel, Associatie Universiteit Gent, Associatie KU Leuven and Associatie Universiteit-Hogescholen Limburg and is managed by FWO Research Foundation - Flanders.

• info@vscentrum.be

The EuroHPC Joint Undertaking brings together the European Commission and 32 participating states

including Belgium for the development of a World Class European Supercomputing Ecosystem. The Flemish Administration (EWI) holds the delegates seat in the EuroHPC governing board.

• **Geert Vangrootel**
geert.vangrootel@vlaanderen.be

**LARGE SCALE
RESEARCH
INFRASTRUCTURES
IN FLANDERS**

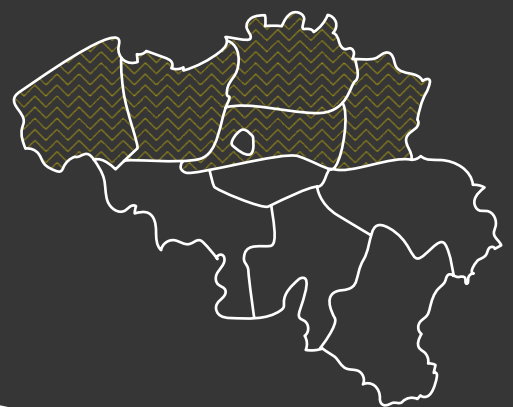

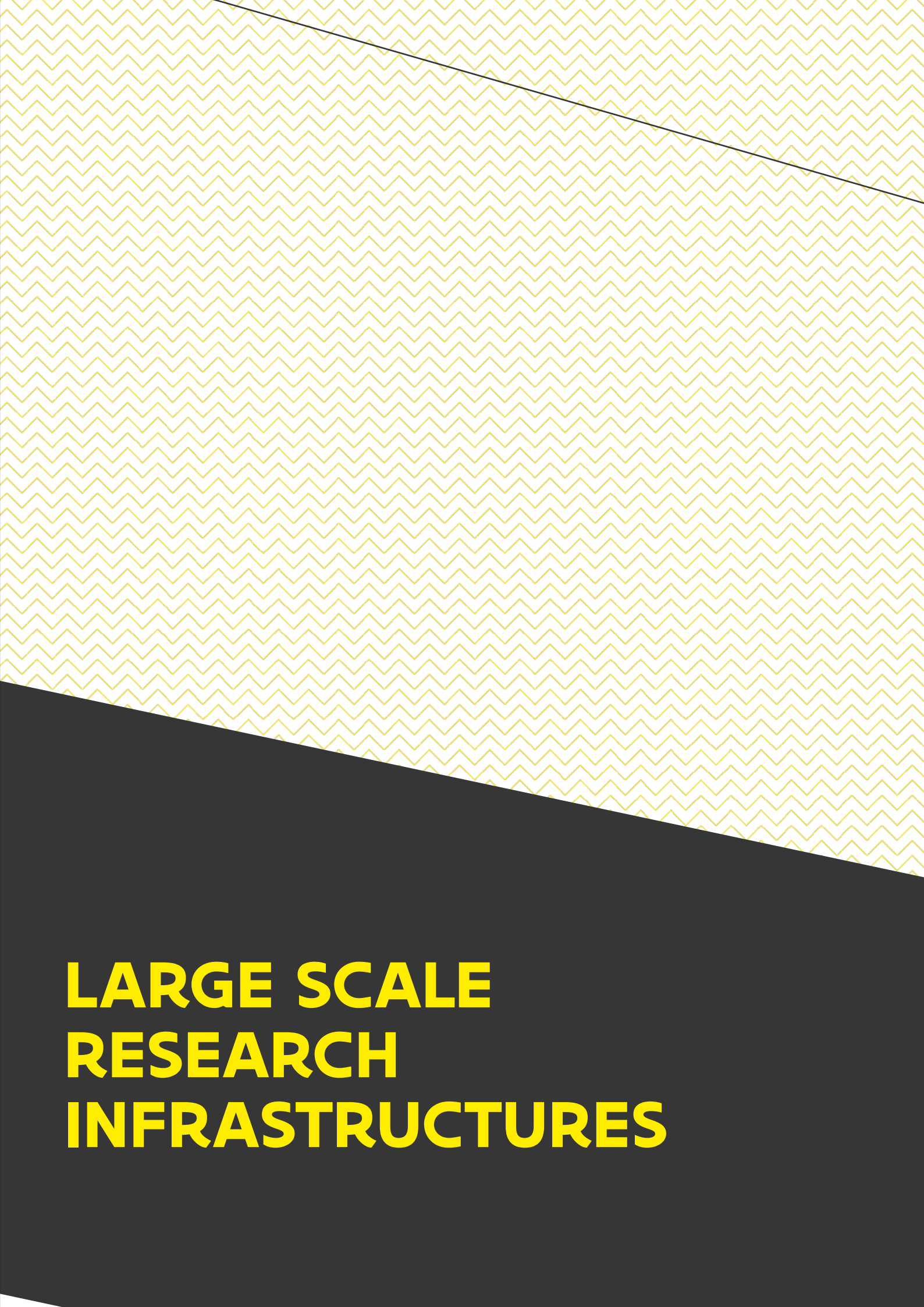

**LARGE SCALE
RESEARCH
INFRASTRUCTURES**

POLYLINE

A Testing Infrastructure for Smart Energy Chains

The PolyLine system consists of two synergetic facilities, operating at medium-to-high voltage levels: a traditional, single/three-phase AC (50Hz, 60 Hz)/DC + impulse facility; a three-phase synthetic grid with floating current injection; equipment for the generation and capture of complex system transients and non-ideal behaviours that is not available in traditional testing facilities; amplifier-driven sources that enable equipment, sensors, and protection devices to be exposed to fully user-programmable unbalance, harmonics, transients, reproductions of recorded grid faults, fluctuations in fundamental frequencies, interactions with control devices, etc.; hardware-in-the-loop simulations that validate smart-device interactions with a complex system.

Activities, Equipment and Services

Generation and measurement of high voltages and selected currents in 3-phases, AC and/or DC; surge voltage generation and measurement; partial discharge and tan-delta measurements; pre-certification testing at applicable standards; selected mobile (off-site) capabilities; hardware-in-the-loop device testing using real-time simulation; custom measurements and experimental configurations for tests of out-of-the-ordinary cases; research and consulting services, including product (re)design support.

Impact and Importance

PolyLine supports research into smart sensors, asset condition monitoring and smart grid components on the medium-voltage level. The laboratory also supports local companies in their development of innovative products operating at higher voltages.



Flexible medium- and high-voltage testing for innovative devices.

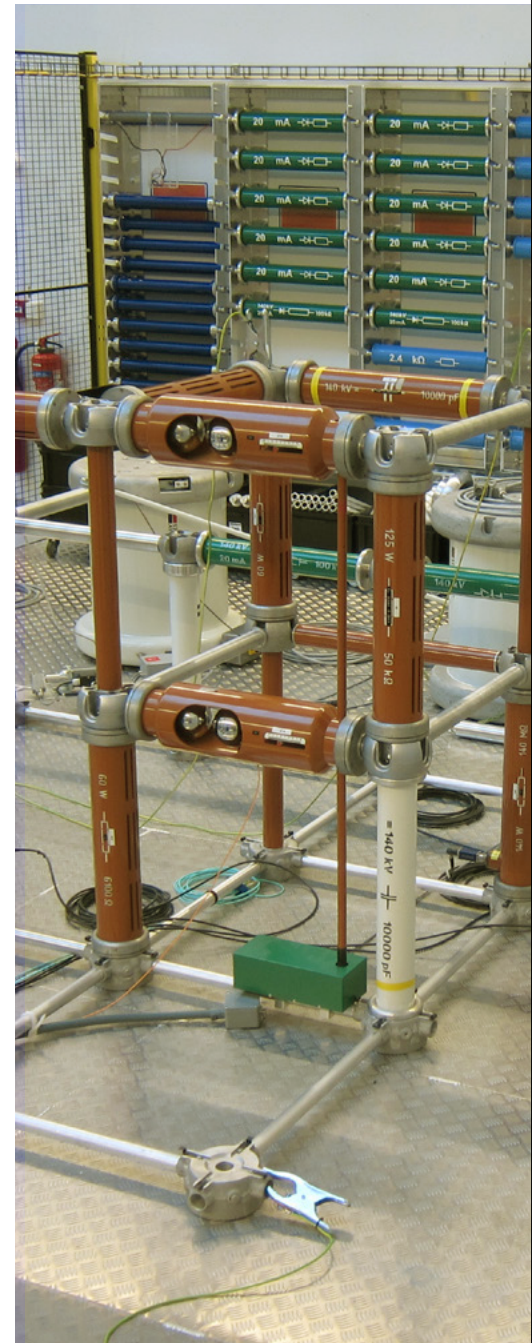

PolyLine

IN FLANDERS ACTIVE SINCE

2018

FIND US ONLINE

www.energyville.be/labs/middenspanning-labo

USER ACCESS

www.energyville.be/en/labs/medium-voltage-lab

CONSORTIUM

[EnergyVille / KU Leuven](#)
ESAT/ELECTA
EnergyVille 1, Thor Park 8310, 3600 Genk

• **Kris Baert**
kris.baert@energyville.be
+32 16 32 83 96



© ENERGYVILLE

3TESLAMRI

An integrated multimodal platform for brain mapping at high spatiotemporal resolutions:
3teslaMRI infrastructure





© 3TESLAMRI

A magnetic resonance imaging (MRI) scanner with a field strength of 3 tesla, capable of performing imaging of the brain in human subjects, complemented with peripheral equipment for functional imaging and integrated electroencephalograms.

Activities, Equipment and Services

The infrastructure offers state-of-the-art neuro-imaging of the functioning, structure and metabolism of the human brain. The site supports researchers in the fields of MR physics, sequence optimization, experimental design and supervised scanning. Additionally, it provides the opportunity to develop expertise in data analysis and image processing.

Impact and Importance

The 3T infrastructure is an enormous stimulant for the neuroscience community within Leuven, Flanders, and beyond. It has already led to more than 200 international full publications and more than 40 doctoral theses. It continues to serve as a catalyst for new projects and international partnerships, strengthening the Flemish position in the international neuroscience research field. It has led to and continues to lead to translational applications that can be successfully implemented in the healthcare sector.

3teslaMRI

IN FLANDERS ACTIVE SINCE

2014

FIND US ONLINE

www.gbiomed.kuleuven.be/english/research/50000677

USER ACCESS

Available upon request

CONSORTIUM

 **KU Leuven**

Translational MRI
Herestraat 49, 3000 Leuven

- **Stefan Sunaert**
stefan.sunaert@uzleuven.be
+32 16 34 90 21

CAPS-IT

An automated platform for multi-parameter data collection on live pathogens with a high or unknown biosafety risk

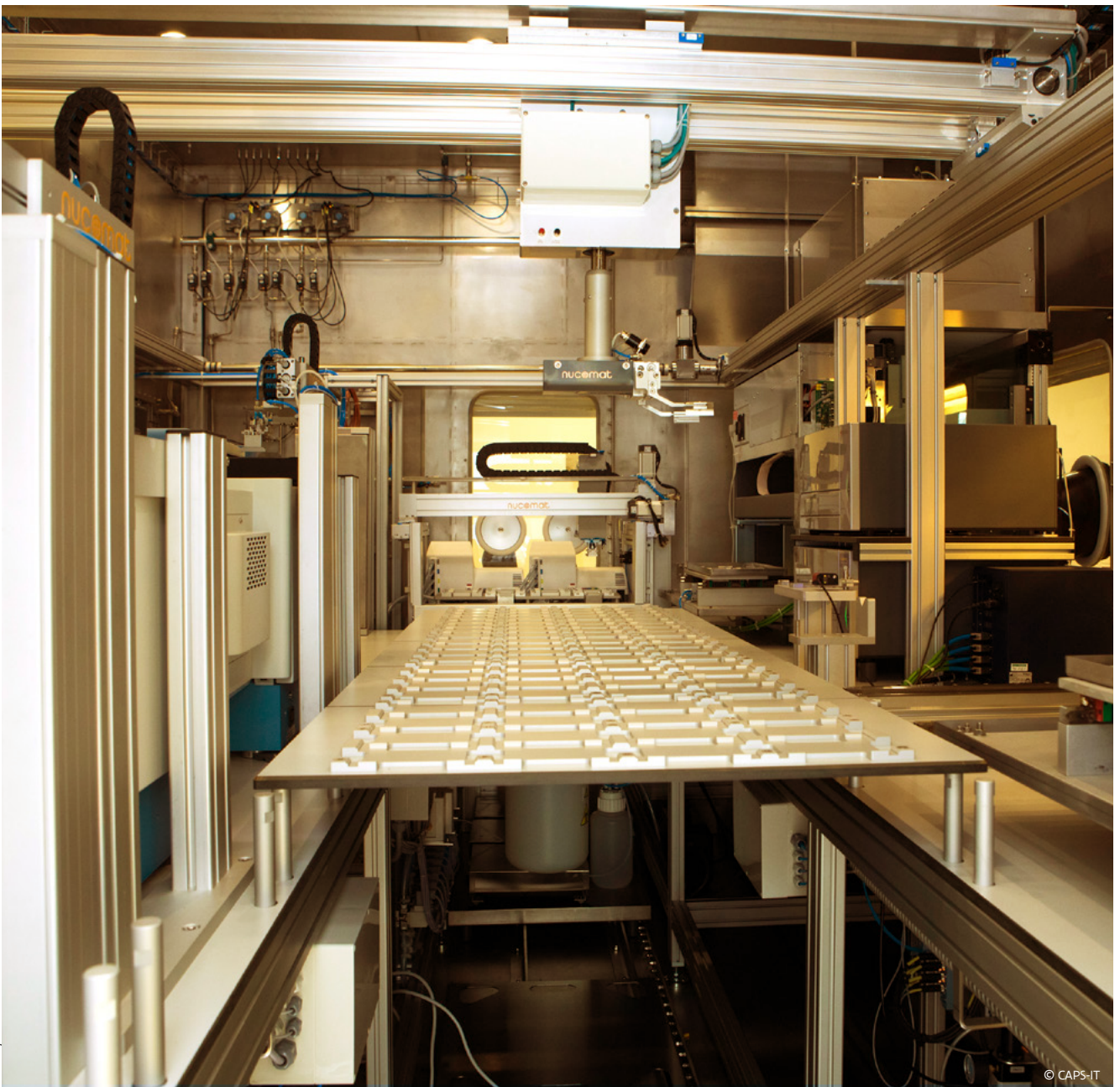



Caps-It

IN FLANDERS ACTIVE SINCE

2018

FIND US ONLINE

- www.rega.kuleuven.be/cmt/capsit
- www.antivirals.be
- [youtu.be/cr2-fvGPKos](https://www.youtube.com/channel/UCr2-fvGPKos)

USER ACCESS

- www.rega.kuleuven.be/cmt/capsit

CONSORTIUM

 Rega Institute, KU Leuven
Laboratory of Virology and
Chemotherapy
Herestraat 49, 3000 Leuven

- **Johan Neyts**
johan.neyts@kuleuven.be
+32 16 32 18 93

The Caps-It research infrastructure is a 'pathogen-in'-'human-out' 'lab-in-a-box' system for research into and with infectious microorganisms with a high or unknown biosafety risk. The replication of highly pathogenic viruses and the multiplication of multidrug-resistant bacteria and fungi can be studied in the context of the host-cell environment, resulting in fundamental insights into and the development of novel therapeutic strategies against molecular mechanisms that are essential for propagation and pathogenicity.

Activities, Equipment and Services

The core of the Caps-It research infrastructure consists of two confocal high-content imagers. These instruments allow the imaging of extra- and intracellular processes. By integrating them into an automated environment with incubators, plate washers and liquid handlers, it's possible to perform large-scale data and sample collections in model systems with the infectious pathogen, over time and independent

of time. The Caps-It research infrastructure is suitable for high-throughput research, collecting massive amounts of data during the development and validation of novel model systems. Subsequent high-throughput screening in these model systems allows the evaluation of the anti-infective potential of small-molecule inhibitors, peptides, nanobodies, antibodies, as well as the development of diagnostic applications or the standardized production of pathogen samples.

Impact and Importance

The Caps-It research infrastructure is a unique system. It combines the ability to perform high-throughput, large-scale data collection using high-content imaging in the context of assay systems, and applications in which infectious pathogens with a high or unknown biosafety risk are used. As a consequence, this research infrastructure is uniquely positioned at the interface of the EU ERINHA, EU-OPENSREEN and EURO-BIOIMAGING ESFRI research infrastructures.



Lab-in-a-box for
infectious disease
research and drug
discovery.

CRYO-TEM

Cryogenic Transmission Electron microscope for high-resolution single particle analysis and cryo-tomography of biological samples

The high-resolution 300kV JEOL cryoARM electron microscope is the latest generation cryogenic microscope manufactured by JEOL. It is the principal instrument of the BECM cryo-EM facility situated at the VUB campus in Brussels. cryoARM300 enables imaging of biological macromolecules in vitreous ice in automated high-resolution. The collected images are used to reconstruct the 3D structure of proteins and protein complexes at near-atomic or atomic resolution. The 3D models of the proteins based on these 3D maps are used to learn about the function of biological molecules and enable visualization of bound small molecules to facilitate rational drug design.

Activities, Equipment and Services

The cryoARM300 enables high-resolution and high-throughput collection of single-particle cryo-EM data and cryo-tomograms. The cryoARM300 is housed in the VIB-VUB

facility for Biological Electron Cryogenic Microscopy (BECM). BECM includes a laboratory for sample preparation, two JEOL JEM-1400 screening microscopes, the cryoARM300, and IT infrastructure consisting of a data storage server and GPU stations for image processing. The facility offers services and support for the complete workflow of single particle cryo-EM from the initial steps of the preparation of cryo-EM grids to computational image processing and reconstruction of the 3D structure. In addition, the facility offers trainings for all steps of the workflow, it offers access to the screening and high-resolution microscopes, and provides consulting on cryo-EM projects.

Impact and Importance

Knowledge of the structures of biological macromolecules helps us to understand how living organisms function. Structures of biological molecules also form a basis for rational drug design. Single particle cryo-EM is a method that has undergone rapid development in the past 5 years and now enables the determination of the atomic structures of complex biological molecules without the need to crystallize them. Having a state-of-the-art high-resolution cryo-EM facility in Flanders is critical for basic research in biology and will have a significant impact on the pharmaceutical industry in the region.

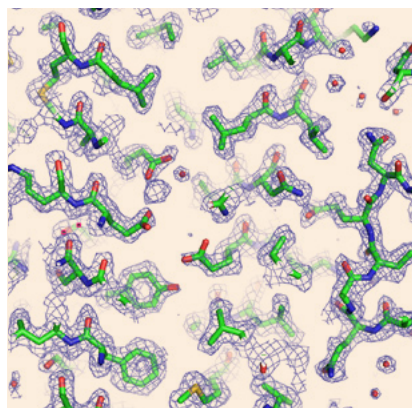

© VUB

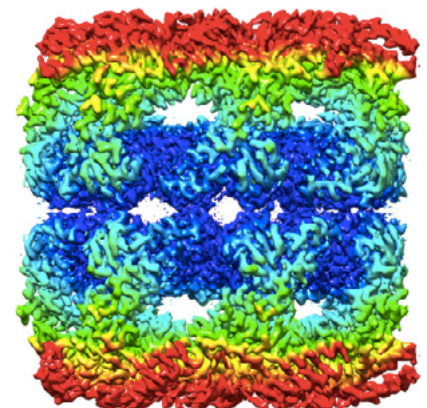

© VUB

Cryo-TEM

IN FLANDERS ACTIVE SINCE

2018

FIND US ONLINE

www.becm.be

[BECM_VIB](https://twitter.com/BECM_VIB)

USER ACCESS

www.becm.be/services

CONSORTIUM

[VIB Center for Structural Biology](#)
E4.4, VUB, Pleinlaan 2, 1050 Brussels

• **Rouslan Efremov**
rouslan.efremov@vub.vib.be
+32 2 629 10 25



© VUB



Thanks to high-resolution cryo-EM microscope we can now see proteins at atomic resolution.

KU LEUVEN FACS CORE FACILITY

KU Leuven FACS Core Facility

The KUL FACS core facility hosts 6 instruments for flow cytometric analysis: (a) ThermoFisher Attune with 2 lasers/6 detectors, (b) Beckman Coulter Gallios with 3 lasers/10 detectors, (c) BD FACSVerser with 3 lasers/8 detectors, (d) two BD Canto II instruments with 3 lasers/8 detectors, and (e) BD FACSSymphony A3 with 5 lasers/28 detectors. We further host 4 cell sorters: BD Influx with 4 lasers/16 detectors, (b) BD FACSAria III with 4 lasers/12 detectors, (c) BD FACSAria

IIu with 2 lasers/9 detectors, and (d) BD FACSMelody with 3 lasers/8 detectors. Beyond these instruments, we are equipped with an Amnis ImageStream MK2 (1 laser, 5 channels, 40x objective) for imaging cytometry and a CyTOF3 (Helios) for mass cytometry.

Activities, Equipment and Services

The KUL FACS core facility provides flow cytometric, mass cytometric, imaging cytometry and cell sorting services for BSL1 and BSL2 samples to KU Leuven and VIB researchers as well as to external clients. Flow cytometric and cell sorting services are offered as staff-operated or (for most equipment) user-operated after training by FACS core facility staff. The core facility organizes regular training events to introduce instrumentation or analysis software as well as seminars and symposia with international speakers.

Impact and Importance

Cytometry is an indispensable technology to fundamental/basic research in all domains dealing with live material ranging from lower to higher organisms as well as to clinical research including human samples and diagnostics. Accordingly, our clients include scientist and clinicians from all (bio-)medical domains. To meet the high expectations we have implemented technology of highest standard such as high-end flow cytometry with up to 30 parameters, mass cytometry and imaging cytometry. High-end cell sorting for BSL2 samples meets the needs of especially clinical researchers.

The facility is governed by a scientific director and a steering committee who advise the executive manager.

 The core facility organizes regular training events to introduce instrumentation or analysis software as well as seminars and symposia with international speakers

KU Leuven FACS Core Facility

IN FLANDERS ACTIVE SINCE

2014

FIND US ONLINE

- 🌐 www.gbiomed.kuleuven.be/english/corefacilities/facs
- 🌐 www.gbiomed.kuleuven.be/english/corefacilities/facs/News

USER ACCES

- 🌐 www.gbiomed.kuleuven.be/english/corefacilities/facs

CONSORTIUM

📍 **KU Leuven FACS core facility
multi-departmental service unit**
Campus GHB, Herestraat 49,
3000 Leuven

• **Susan Schlenner**
susan.schlenner@kuleuven.be
+ 32 16 37 98 45

• **Pier-Andrée Penttilä**
pier-andree.penttila@kuleuven.be
+ 32 16 37 70 80



NEXTGENQBIO

Next Generation Screening in Quantitative Biology & Drug Discovery



© PIETER CLICTEUR

NextGenQBio offers a multi-sited research infrastructure that consists of three platforms: a high-throughput, high-content screening platform (HT-HCS platform) comprising an automated confocal microscope integrated with plate/liquid handling devices; an automated cell-culture platform for induced pluripotent stem cells and other cell work (iPSC platform) and an integrated pipeline of image analysis/storage software and IT infrastructure (BioIT platform). The HT-HCS and BioIT platforms are located at the VIB-UGent campus in Zwijnaarde, and more

specifically, at the VIB Screening Core and the Ghent University Expertise Centre for Bioassay Development and Screening (G-BIOS). The iPSC platform is located at the Gasthuisberg campus in Leuven, and more specifically, at the Stem Cell Institute Leuven.

Activities, Equipment and Services

A dedicated team of experts operates the platforms and assists researchers in the development, miniaturization and automation of bioassays relevant for disease and biological pathways. The infrastructure is compatible with

NextGenQBio

IN FLANDERS ACTIVE SINCE

2019

FIND US ONLINE

[www.vib.be/en/about-vib/Pages/
NextGenQBio-A-better-view-on-cells.aspx](http://www.vib.be/en/about-vib/Pages/NextGenQBio-A-better-view-on-cells.aspx)

USER ACCESS

not yet available

CONSORTIUM

VIB, KU Leuven
**Switch Laboratory, VIB-KU Leuven Center
for Brain & Disease Research**
Campus Gasthuisberg O&N1,
Herestraat 49 Box 802 room 08.683,
3000 Leuven

• **Frederic Rousseau**
frederic.rousseau@kuleuven.vib.be
+32 16 37 25 70



The effect of a large number of perturbants can be assessed at the cellular level, including rare events and subtle alterations at the single cell and subcellular level.

bioassays in conventional cell models, but also with induced pluripotent stem cells and 3D cell cultures, enabling the most accurate possible capture of disease biology. These bioassays can be applied to analyze a large number of samples in high-throughput mode via high-content imaging. A diverse set of 45,000 drug-like synthetic molecules and a human siRNA collection (8,000 genes, the druggable genome) is available to set-up these high-throughput screenings.

NextGenQBio provides operational support at different levels of discovery:

- converting microscopic observations into high-content quantitative parameters;
- miniaturizing and automating disease-relevant bioassays;
- performing multi-parametric image-based screenings in high-throughput mode;
- biological profiling of drugs/compounds in bioassays.

Impact and Importance

Quantitative biology is gaining ground in molecular life science research, relying on high-content imaging; i.e. quantifiable, computable and multi-parametric analysis of complex biological assays in miniaturized format. Such multiplexed information allows for deep and unbiased insights into molecular mechanisms underlying biological phenotypes. Combining high-content image analysis with high-throughput screening enables the assessment of rare events, subtle alterations and subcellular processes in subpopulations of cells and at the single cell level in high-throughput mode.

This joint effort between VIB, the Stem Cell Institute Leuven, KU Leuven and UGent will open avenues to generate chemical tools/probes for the study of biological processes and to validate targets/modes-of-action for a range of disease areas.

PACBIO SEQUEL I

Long Read Sequencer



Solving complex and repetitive genomic regions.

The new Sequel System from Pacific Biosciences is based on Single Molecule, Real-Time (SMRT) technology. With 1 million zero-mode waveguides (ZMWs) per SMRT Cell, it delivers about seven times as many reads as the PacBio RSII. This seven-fold increase in output results in a three-fold decrease in the cost per base.

Activities, Equipment and Services

Pacbio Sequel is a DNA sequencer that can generate long, high quality sequences at single-molecule resolution. It may be used to sequence repetitive genomic regions, de novo assembly and full-transcript RNA sequencing. The services, which include support in library prep, QC, sequencing and analysis, run through the Genomics Core (www.genomicscore.be).

Impact and Importance

PACBIO Sequel complements the available services for DNA sequencing in Leuven, allowing everybody to address complex genetic questions, from small experiments to large-scale

projects. The Sequel is embedded in the Genomics Core which assists in our ability to offer the entire process as a service. It acts as a knowledge hub for DNA-sequence analysis and technology. The public service access ensures overall cost-effectiveness of such activities. It will bring an end to their current dispersion across numerous individual groups, also eliminating existing infrastructural bottlenecks.

The application of the PacBio technology extends far beyond the key focus of the current applications - the boundaries of human genetic research but reaches out to users from all biological disciplines, including biomedical, agricultural and biological sciences. At present, over 100 research groups both from within and outside the University have made use of the facility. Furthermore, over the past two years, several small Flemish companies and research institutes, as well as users from other universities, have made use of the services we provide.



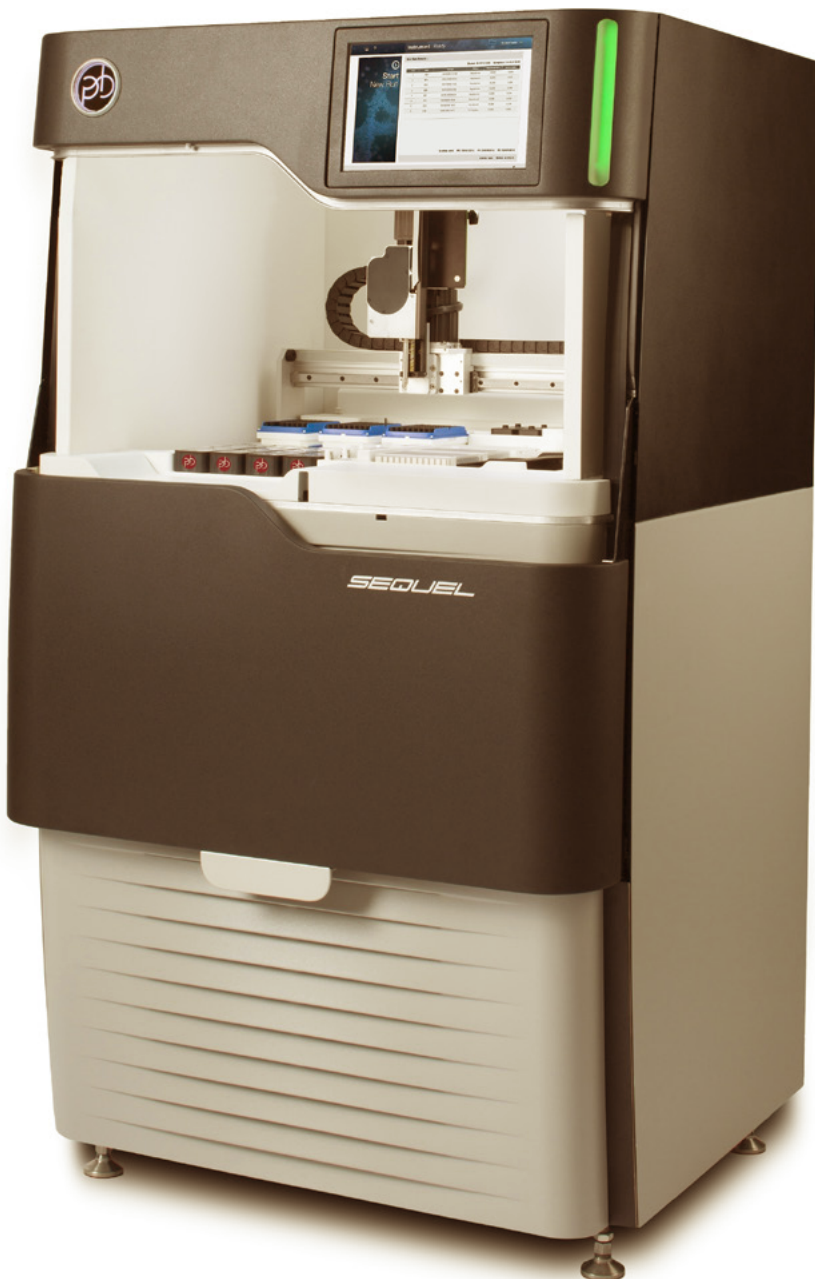

PacBio Sequel I

IN FLANDERS ACTIVE SINCE

2016

FIND US ONLINE

www.genomicscore.be/instruments_services/pacbio-sequel

USER ACCESS

www.genomicscore.be/instruments_services/pacbio-sequel

CONSORTIUM

[UZ Leuven/KU Leuven](#)
Laboratory of Cytogenetics and Genome Research
campus Gasthuisberg, Herestraat 49, B, 3000 Leuven

- **Joris Vermeesch**
joris.vermeesch@uzleuven.be
+32 16 34 59 41 or +32 16 34 26 72
- **Wouter Bossuyt** (Manager)

PHENOVISION

A plant phenotyping platform



The VIB-UGent department hosts several plant phenotyping platforms for the automated imaging and the precision irrigation of plants. The combination of automated plant handling with non-invasive imaging methods yields insight into a variety of physiological, morphological

and growth-related traits of plant development. As well as the study of different genotypes, the platforms allow the investigation of different soil types/growth substrates, multiple irrigation schemes, biological/chemical irrigation or spraying applications, and more.

PHENOVISION

IN FLANDERS ACTIVE SINCE

2014

FIND US ONLINE

www.psb.ugent.be/phenotyping-platforms

[InzeDirk](#)

USER ACCESS

The infrastructure is accessible to both industry and academia. Please, contact us via phenotyping@psb.vib-ugent.be.

CONSORTIUM

 **VIB-Ugent Center for Plant Systems Biology**
Systems Biology of Yield
Technologiepark 71, 9052 Gent

• **Dirk Inzé**
dirk.inze@psb.ugent.be
+32 9 331 38 00

Activities, Equipment and Services

The PHENOVISION platform is a greenhouse infrastructure for automated, high-throughput phenotyping of crops up to 2m in height. It has a capacity of 392 plants. Pots are transported in carriers on a conveyor belt system. There are three weighing and irrigation stations with rotating platforms, with the possibility of incorporating up to four different solutions and imposing soil, water or nutrient deficit conditions. RGB cameras, in a multi-view imaging set-up, provide measurements of morphological and growth-related phenotypic traits. A thermal infrared camera measures leaf temperature, used as an alternative for registering plant water consumption. A state-of-the-art hyperspectral imaging system, consisting of a visible to near-infrared camera and a short-wave infrared camera, captures plant reflectance spectra from which physiological information is discerned.

Impact and Importance

Automated plant phenotyping installations require an interdisciplinary approach. They enable the accurate and reproducible study of the way different plant varieties respond to their environments. This research aims at improving plant production to secure future food supplies in a changing climate. The infrastructure is listed in public databases of phenotyping platforms (EPPN2020, EMPHASIS, and IPPN) and transnational access is provided through the Horizon-2020 project – EPPN2020. Moreover, the infrastructure plays a central role in multiple research projects, fosters scientific collaborations with industry, and provides additional data to support the establishment of spin-off companies.



PHENOVISION,
measuring plants
of the future.

Q-MIP

Quantitative Molecular Imaging Platform

The Q-MIP infrastructure is a MicroSPECT/CT/PET/MRI imaging system for preclinical research.

Activities, Equipment and Services

The Q-MIP infrastructure is part of the VUB's In vivo Cellular and Molecular Imaging (ICMI) core facility. It features multiple preclinical imaging modalities including CT, SPECT, PET, MRI, bioluminescence and near-infrared fluorescent imaging, together with a radiochemistry unit, alpha therapy unit, flow cytometry and an animal vivarium.

This infrastructure allows work with radioactive materials needed for in vitro and in vivo testing of novel imaging diagnostics and targeted radionuclide therapy (TRNT).

Impact and Importance

The Q-MIP infrastructure allows the measurement of in vivo biodistribution and tissue-targeting of novel drugs. It is unique in allowing the measurement of high-energy photons emitted by the new generation of radiopharmaceuticals for the treatment of cancer. The equipment is of particular interest for academics, and biotech and pharma organizations that develop targeted radionuclide therapeutics. Data acquired using Q-MIP has been used in multiple scientific publications and patents.



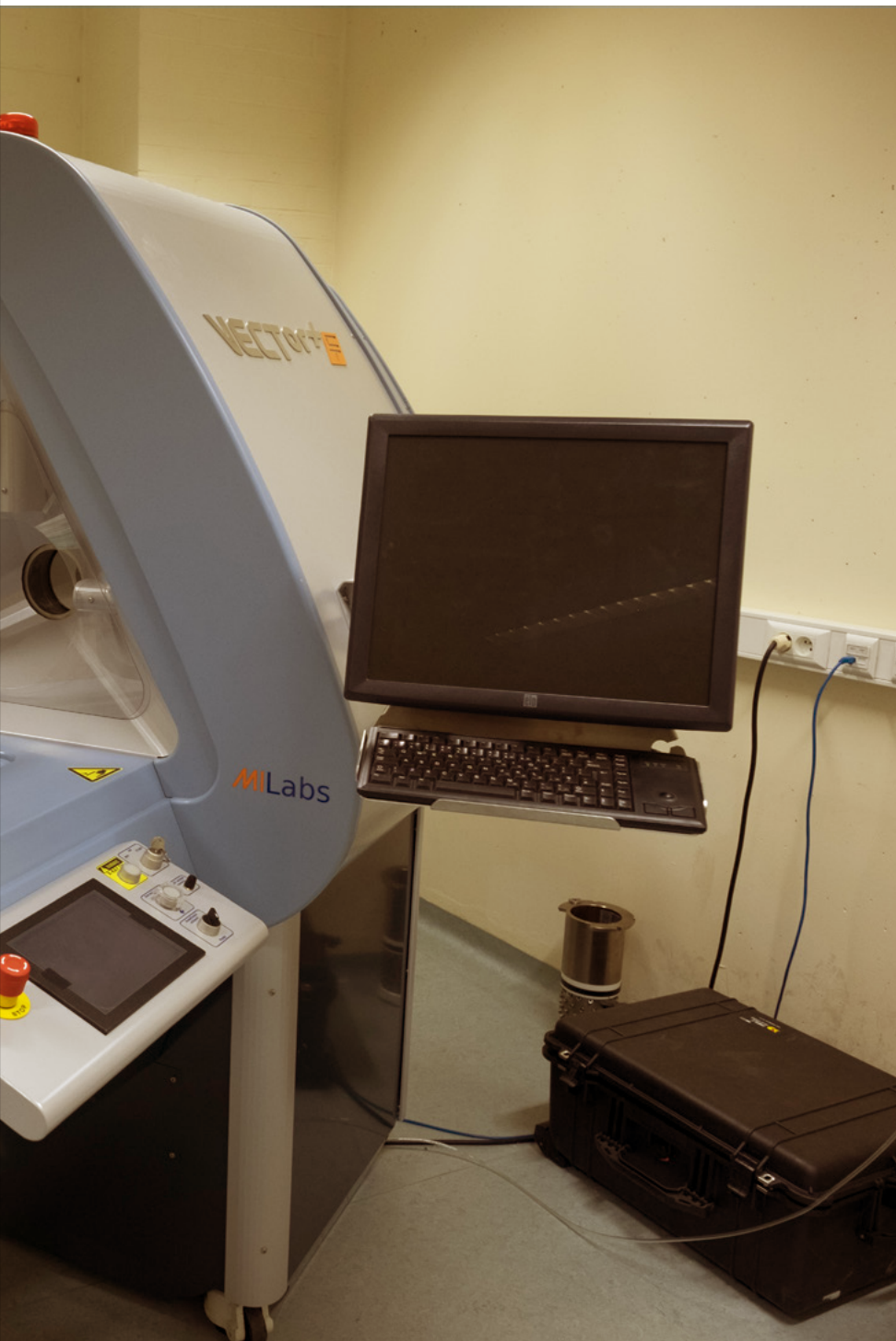

Q-MIP

IN FLANDERS ACTIVE SINCE

2015

FIND US ONLINE

mima.research.vub.be

USER ACCESS

mima.research.vub.be

CONSORTIUM

 **Vrije Universiteit Brussel**
Medical Imaging
Laarbeeklaan 103, 1090 Jette, Building K

• **Tony Lahoutte**
tony.lahoutte@vub.be
+32 2 477 50 20



Q-MIP: Quantitative in vivo biodistribution of innovative drugs.

SPHYNX

Studying PHySiology with NeXt generation Molecular imaging system

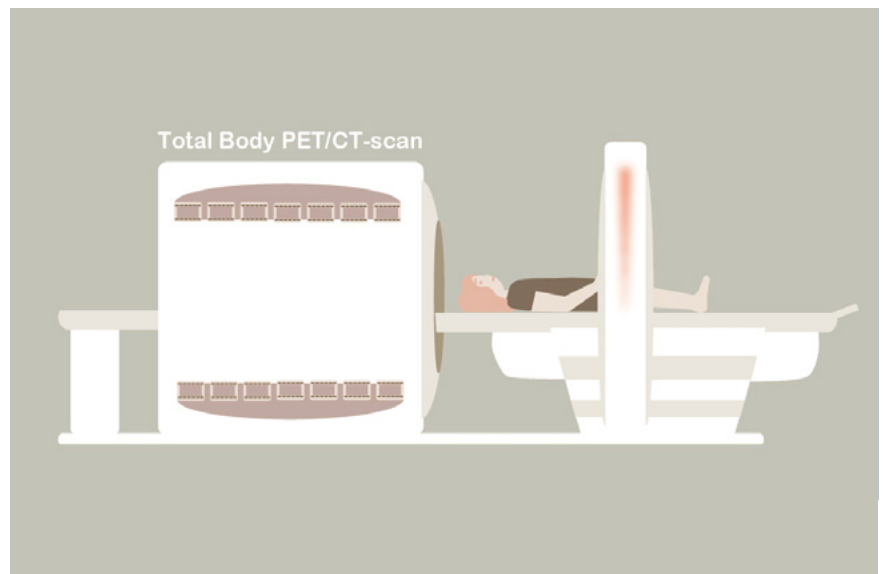
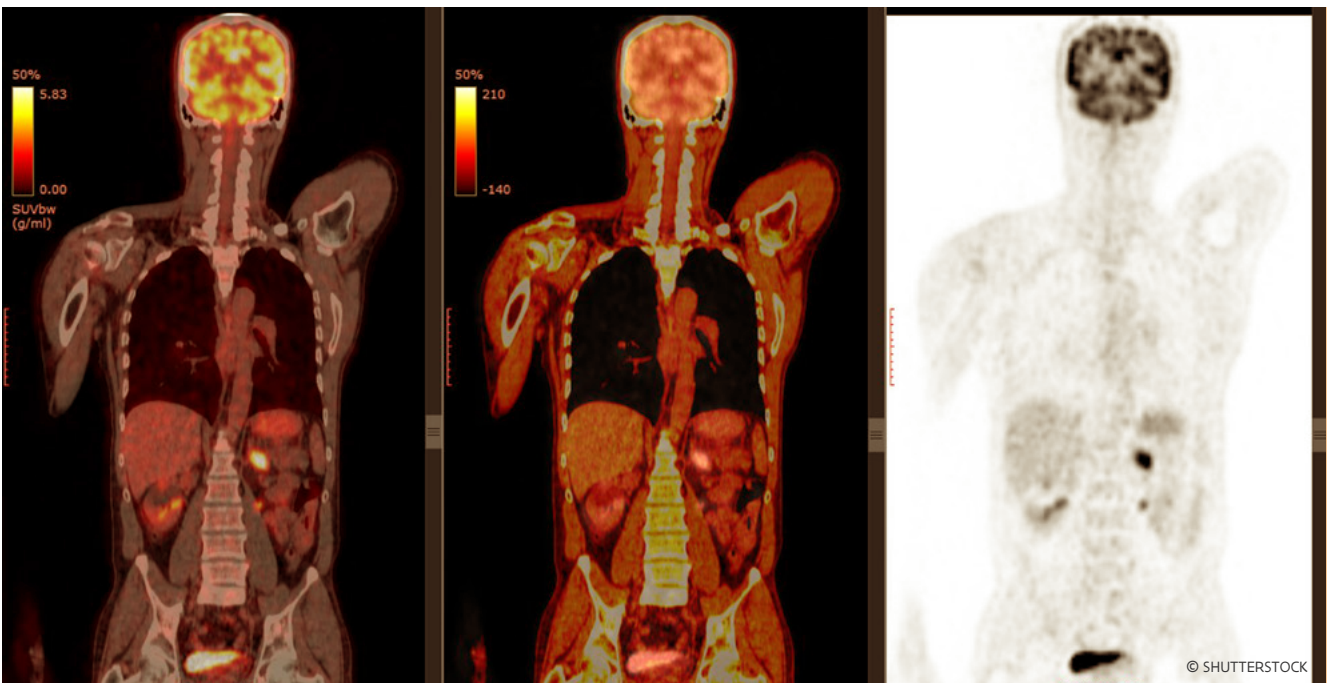

SPHYNX

IN FLANDERS ACTIVE

2021

FIND US ONLINE

 medisip.elis.ugent.be

CONSORTIUM

 **Ghent University**

Medisip

Corneel Heymanslaan 10, 9000 Gent

- **Stefaan Vandenberghe**

Stefaan.vandenberghe@ugent.be

+32 9 332 58 54

The long term goal is to build a high-resolution total body time-of-flight PET scanner of at least 150 cm to be deployed as a research tool to study physiology in plants, large animals and humans. Current Positron Emission Tomography devices have 3 to 5 rings of detectors. The Sphynx is to concatenate and integrate 30 or more detector rings to obtain a long detector cylinder. The device will be large enough to house large subjects for single-shot imaging. The sensitivity will be 30 times better, the axial field of view 6-8 x longer, and spatial resolution twice as good.

Activities, Equipment and Services

The Sphynx has been developed to research physiology: the biological science that deals with the life-supporting properties, functions and processes of living organisms or their components. The scope includes complete living systems, organ systems, individual organs and tissues. The physiology and pathology of humans, animals and plants will be able to be studied with the Sphynx device.

Impact and Importance

The Sphynx device is to be a research instrument widely used for studying animal, human, and plant physiology. The technological applications of new insights in physiology gained through Sphynx are manifold. Applied animal physiology leads to solutions for agriculture, animal husbandry and the veterinary sciences. Applied human physiology leads to solutions for medicine, healthcare and pharmacology. Applied plant physiology leads to solutions for agriculture, plant husbandry, agronomics, forestry, ecosystem management. Results from Sphynx may lead to new clinical therapies (drugs, cellular therapy, radiotherapy, surgical procedures, transplantation strategies, etc.), better agricultural practices, new crop protection strategies, improved diagnostics, better animal models, improved plant cultivars, new animal breeds, etc.



Total body PET
for studying
physiology.

COMBINED TOFSIMS-IN SITU SPM INSTRUMENT

Towards 3D-nanochemical analysis:
Combined TOFSIMS-SPM infrastructure
at the service of R&D in Flanders

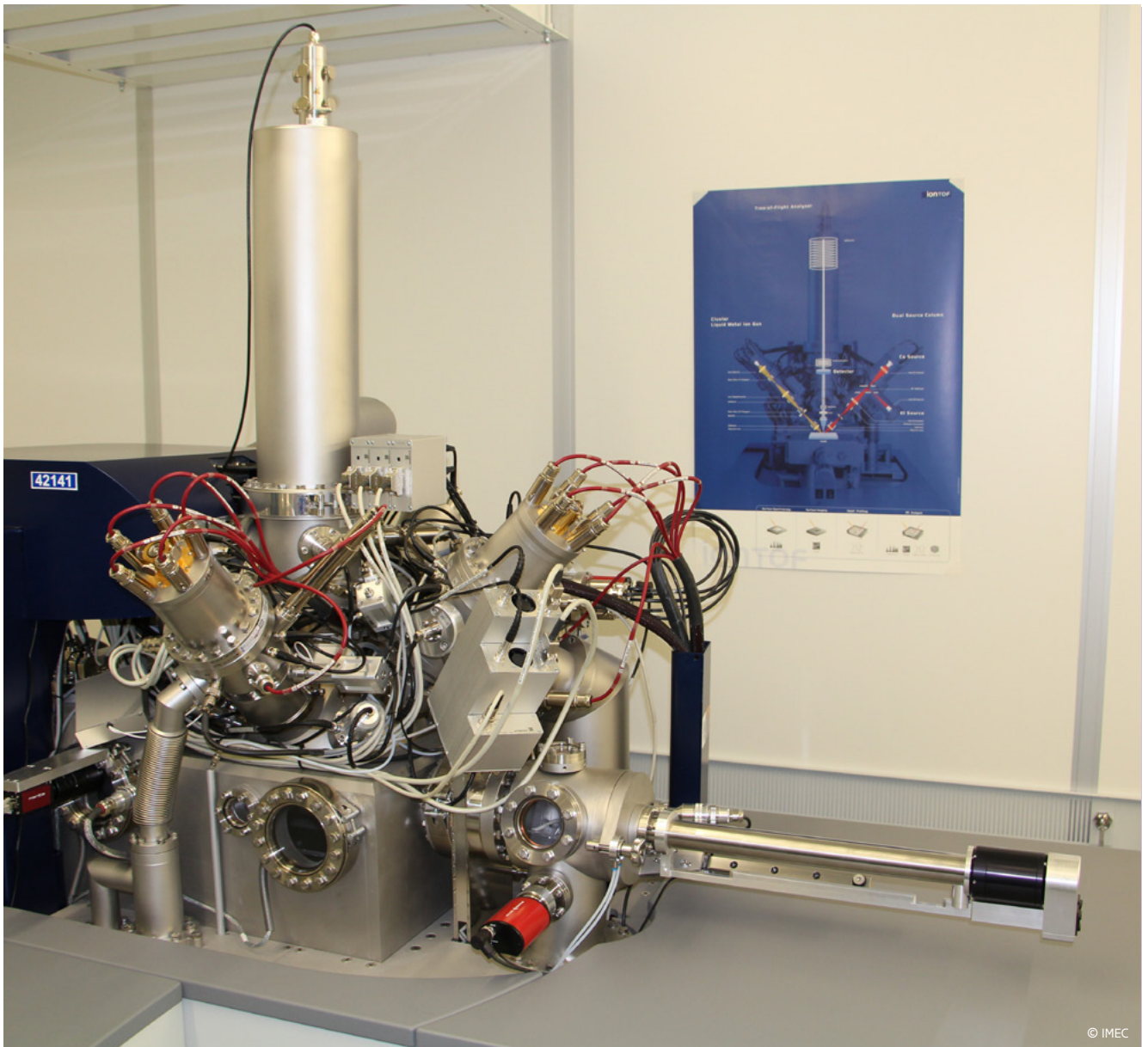

Combined TOFSIMS-in situ SPM instrument

IN FLANDERS ACTIVE SINCE

2016

USER ACCESS

www.metro4-3d.eu/index.php?option=com_content&view=article&id=3

CONSORTIUM

 imec

MCA

Kapelde reef 75, 3001 Heverlee

• Alexis Franquet

franquet@imec.be

+32 16 28 75 00

Material science is crucial in technology development and depends extensively on detailed physico-chemical analysis to understand the properties observed. In many fields, organic materials are emerging as replacement materials due to their functionality, lower cost, suitability for large-scale production, conformality in complex shapes. TOFSIMS is well recognized as one of the most powerful concepts to probe organic materials, their interactions and modifications, and their interplay with inorganic structures. The strengths of the infrastructure are that it captures the latest developments in instrumentation (including an in situ SPM allowing real 3D analysis), provides a close interaction with the leading manufacturer and incorporates the leading scientists in the TOFSIMS field.

Activities, Equipment and Services

The infrastructure consists of a fully integrated TOFSIMS with ion sources for depth profiling of organic and inorganic materials (gas cluster ion beam, cesium, oxygen), analytical mass spectrometry with high spatial resolution (BiMn-source) and cross-section preparation (FIB-Ga source). The added value of the in situ SPM module is very high since not only does it allow the topography development induced by the sputtering to be followed and corrected, it also obtains a real 3D analysis and, for example, a direct correlation between local chemistry and electrical conductivity using advanced SPM modes such as Conductive-AFM. The main research and service activities conducted on the infrastructure consist of examining coatings for corrosion inhibition, polymer-metal interactions, organic semiconductors, organic-inorganic interfaces in semiconductors and the science of SIMS metrology.

Impact and Importance

The infrastructure stimulates and facilitates materials research in Flanders, emphasizing areas where organic and hybrid materials and/or the organic-inorganic interface play a dominant role. They include coatings, renewable energies and advanced semiconductor technologies. Thanks to this state-of-the-art metrology infrastructure, crucial developments and innovations in the above-mentioned fields are being made by the consortium partners. The impact of the research performed using the infrastructure has been clearly demonstrated by the high number of publications in scientific journals and participation in workshops and international conferences.



True
3D-nanochemical
characterization for
complex systems
based on inorganics,
organics and hybrid
materials.

FLEMISH ATOM PROBE USER FACILITY

Atom Probe Tomography
for advanced materials studies in 3D

© CLAUDIA FLEISCHMANN, KU LEUVEN

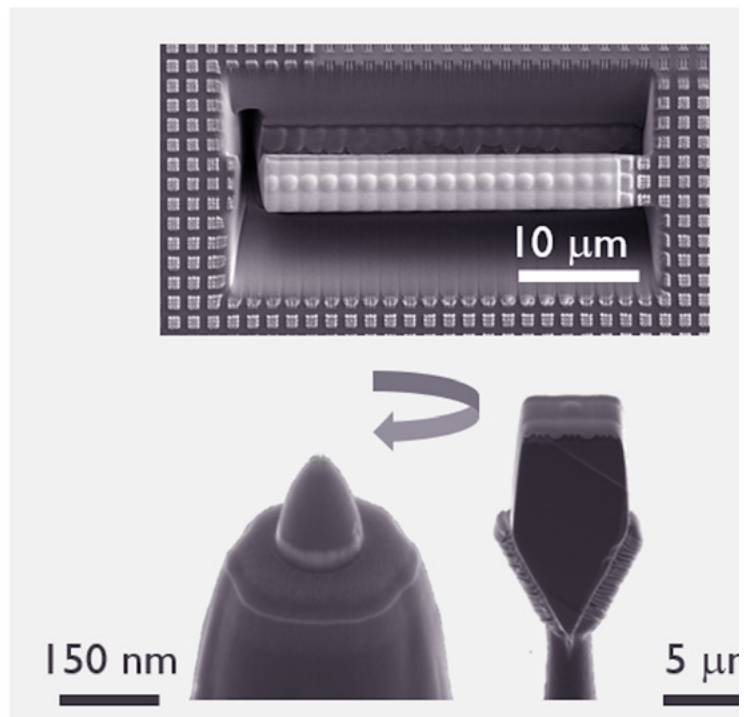
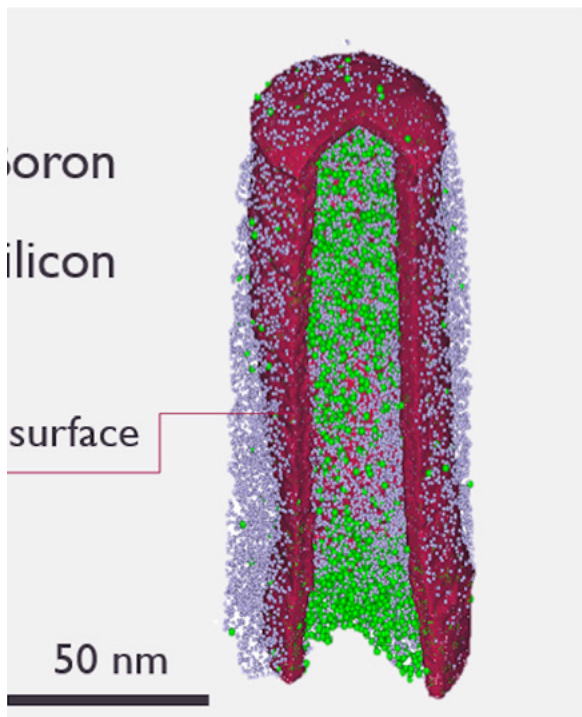

Flemish Atom Probe User Facility

IN FLANDERS ACTIVE SINCE

2016

FIND US ONLINE

 www.apf-flanders.be

USER ACCESS

 www.apf-flanders.be

CONSORTIUM

 Department of Physics and Astronomy
Quantum-Solid State Physics
Celestijnenlaan 200D, 3001 Leuven

• **André Vantomme**
andre.vantomme@kuleuven.be
+32 16 32 75 14

The heart of the research facility is a state-of-the-art atom probe microscope (LEAP 5000XR), that is complemented by a dual-beam focused ion-beam/secondary electron microscope (G3CX Helios Nanolab) and a high-performance computer workstation. Small laboratory equipment and tools for sample handling and preparation, including a vacuum container for sample storage, complete the portfolio. This enables execution, in one laboratory, of a full workflow from sample preparation and atom probe microscopy to data analysis. The laboratory is integrated into a modern, large-scale facility (the Leuven NanoCentre) that offers a vibration-reduced, temperature- and humidity-controlled environment to guarantee excellent tool performance.

Activities, Equipment and Services

The facility offers researchers 3-dimensional, atomic-scale material characterization across various fields, including but not limited to advanced material science. An atom probe microscope yields a 3-dimensional atomic map of a sampled volume (approximately 100 nm x 100 nm x 300 nm), with elemental identification and quantification. This is key to

unravelling (atomic) processes such as film growth, elemental migration, grain boundary enrichment, dopant distribution, clustering, etc. The main activities currently cover advanced materials research for semiconductor applications, nanostructured materials, novel energy materials, complex oxides and advanced steels. At the same time, the research facility is at the disposal of other research institutions and industry, enabling access to the equipment or providing measurement services.

Impact and Importance

Advanced materials research will have a vast impact on our future society and as such forms an essential part in the Flemish research landscape. Innovation in this field originates primarily from obtaining control of material properties at (sub)nanometric level, requiring 3-dimensional atomic-scale metrology. In recent years, atom probe microscopy has led to large-scale advancements in various fields of research and has become indispensable in the Flemish and international research landscape. The atom probe facility is expected to have a large-scale impact on current research programmes in Flanders, allowing the retention and further enhancement of our competitiveness on an international level.



Making the invisible
visible, atom by
atom.

FREEFORM OPTICS

Pilot line for advanced freeform optics:
prototyping, replication and metrology

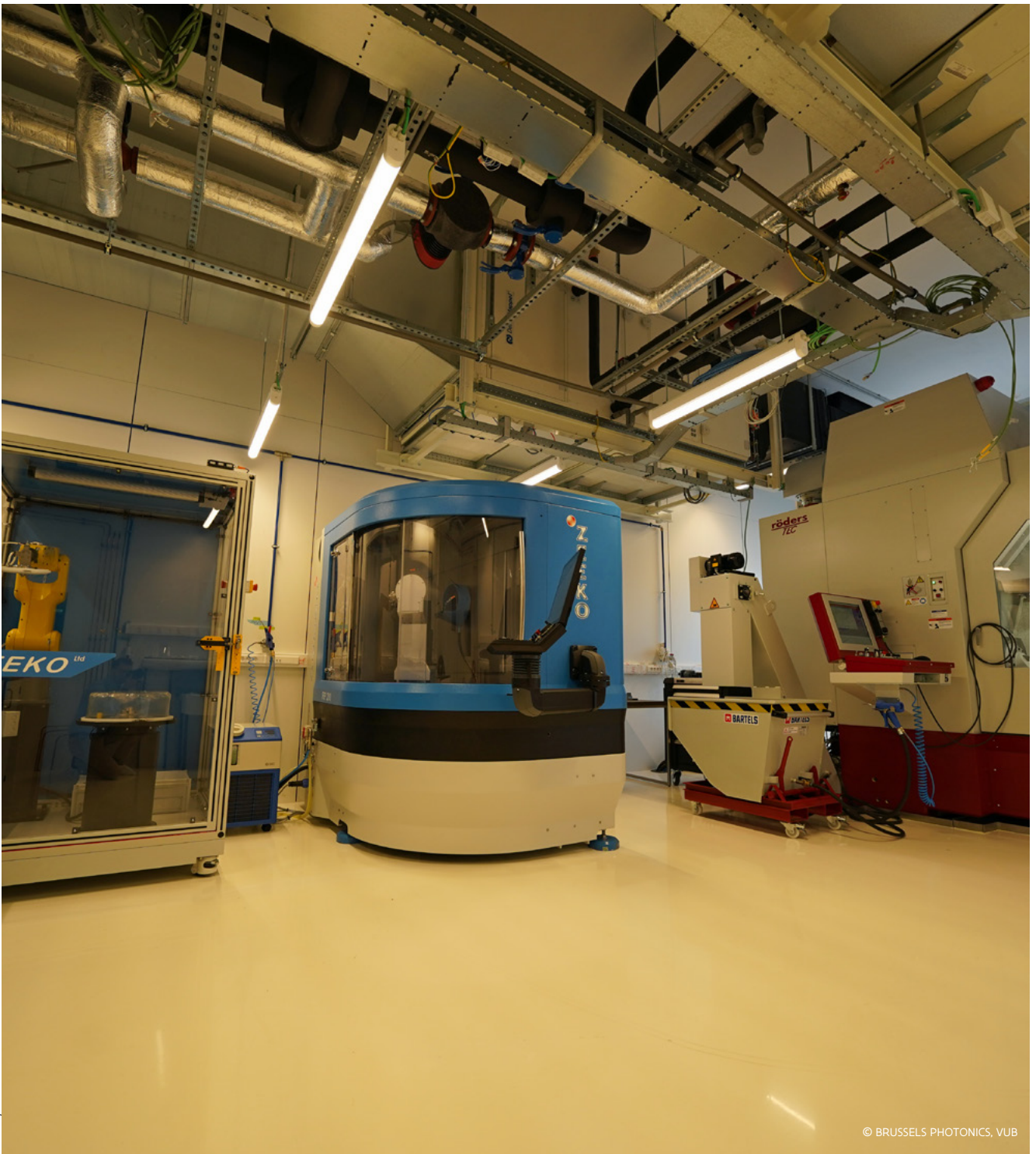

Freeform Optics

IN FLANDERS ACTIVE SINCE

2020

FIND US ONLINE

www.b-phot.org/research/technical-infrastructure

[BPhotVUB](#)

USER ACCESS

Access with or without support B-PHOT experts.

www.b-phot.org/research/technical-infrastructure

CONSORTIUM

[Vrije Universiteit Brussel](#)
Brussels Photonics

VUB Photonics Campus,
Vollezelestraat 46, 1755 Gooik

• **Hugo Thienpont**
Hugo.Thienpont@vub.be
+32 2 791 68 52

The Freeform Optics pilot line provides all the necessary building blocks for the design, prototyping and characterization of advanced freeform optics in polymers or glass. Freeform optics enable extraordinary imaging and/or light collection functionalities with superior performance and compactness. In addition, the pilot line allows small series production to be performed through fabrication of a mould insert that can be used in a subsequent hot embossing, injection moulding or glass-press moulding process.

Activities, Equipment and Services

The advanced freeform optics pilot line contains a large battery of tools for prototyping and mould making (precision micromachining, ultraprecision diamond tooling, precision bonnet and fluid jet polishing, laser-based micromachining and 3D nanoprinting); for replication (hot embossing, UV embossing, injection moulding, glass press moulding) and for characterization

(full-field interferometry, tilted wave interferometry, white light interferometry, confocal laser scanning microscopy, scanning electron microscopy, coordinate measurement tools, stylus profilometry and atomic force microscopy).

Impact and Importance

This pilot line infrastructure is unique in Flanders and Europe. It will open a range of new research and product innovation possibilities, including “first-time-right” freeform design algorithms, the use of new specialty soft optical glasses, the addressing of new wavelength ranges outside the common visible spectrum, and the first-time use of advanced metrology tools, strongly improving the quality and finish of freeform optics. It will allow companies, working in a variety of industries, to “test before invest” and as such, it will eliminate risk and accelerate innovation of photonic products. Finally this pilot line will establish Flanders as the primary smart photonics region.



VUB's freeform optics pilot line encourages photonics research breakthroughs and product innovation at an unprecedented level.

HAXPES-LAB

High Energy Photoelectron Spectroscopy system

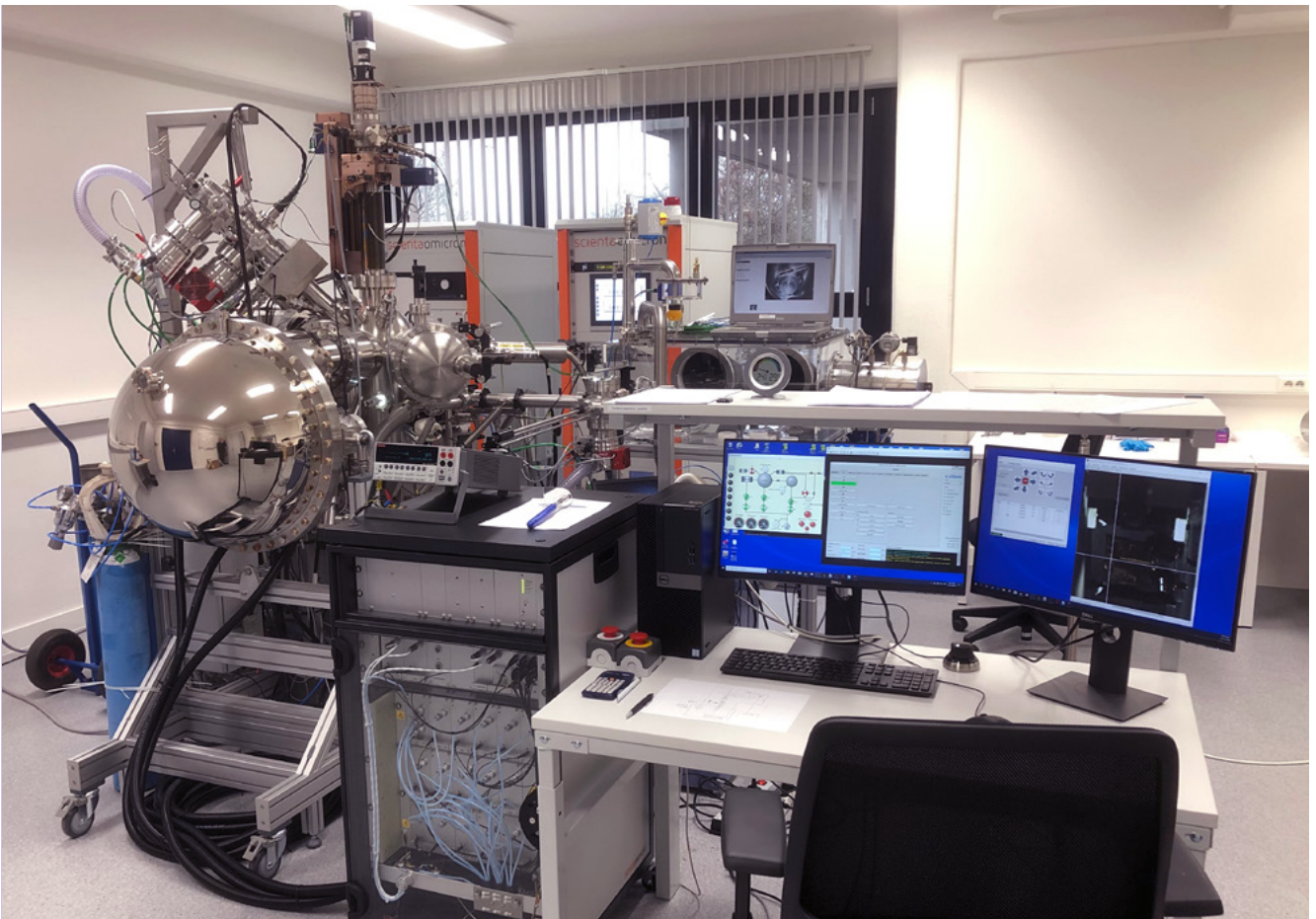

HArd X-ray PhotoElectron Spectroscopy (HAXPES) is a rapidly evolving analytical method that provides much needed insight into material interactions at surfaces and buried interfaces. Recently, a lab-scale HAXPES platform based on monochromatized 9.2 keV photons (Ga) with outstanding sampling depth (up to 50 nm and beyond, material dependent) and photon flux was introduced by Scienta Omicron. As a novel analysis technique in Flanders, HAXPES

has the potential to boost applied research in areas such as batteries, photovoltaics, catalysis, corrosion prevention and semiconductor devices. The instrument is also equipped with a monochromatic 1.5 keV photon source (Al), a mono-atomic Ar⁺ sputtering gun operating between 10 eV and 5 keV, and a Gas Cluster Ion Source operating at 10 keV with cluster sizes ranging from Ar₁ to Ar₂₀₀₀.

HAXPES-lab

IN FLANDERS ACTIVE SINCE

2020

FIND US ONLINE

[www.scientaomicron.com/en/
systemsolutions/electron-spectroscopy/
HAXPES-Lab](http://www.scientaomicron.com/en/systemsolutions/electron-spectroscopy/HAXPES-Lab)

USER ACCESS

for external users: 3000 euro/day (excluding taxes) – for Flemish academia: 500 euro/day; Prices include measurements, data analysis and a report.

CONSORTIUM

 **Institute for Materials Research,
Hasselt University
Nanostructure Physics Group**
Wetenschapspark 1, 3590 Diepenbeek

• **Hans-Gerd Boyen**
hansgerd.boyen@uhasselt.be
+32 11 26 88 91

Activities, Equipment and Services

The consortium presented here is aiming at a high level in materials science, and at the development of HAXPES as a routine analysis method for a wide range of applications. Recognizing the opportunity to benefit their materials research with a user facility that offers easy access to such novel technology, interested parties from academia and industry have joined forces to create this consortium. Semiconductor (KUL, imec), catalysis (KUL), steel and coatings (VUB) as well as energy materials (imec, UHasselt) will be the main areas of material research, with support from industry (Toyota and Solvay). As HAXPES is still an emerging technology, the strong involvement of Scienta Omicron (instrument manufacturer) will further strengthen this user facility.

Impact and Importance

Nanoscience and nanotechnology are both key areas in improving societal needs for better living conditions in the 21st century. Examples include new concepts in information technology, healthcare, energy conversion and energy storage. Progress in these fields builds extensively on proper knowledge of material interactions at surfaces and buried interfaces as they play a crucial role in boosting the performance of batteries, solar cells, catalysts, anti-corrosive coatings, nanoelectronic devices, etc. This obviously requires a detailed understanding of novel materials, material combinations and interactions, which in turn, rely on the development of advanced metrologies such as HAXPES to provide this information.



One of the world's most advanced standalone tools for the non-destructive analysis of new materials.

HYLAFORM

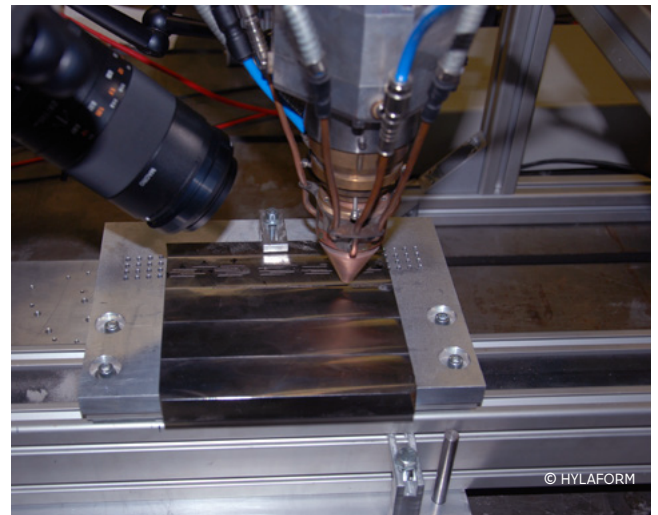
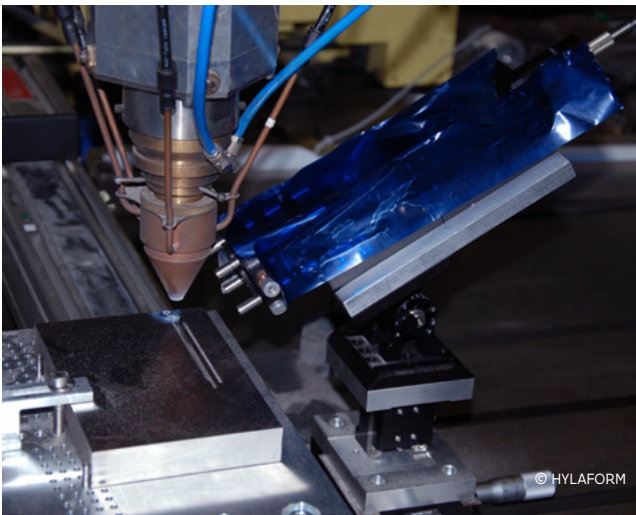
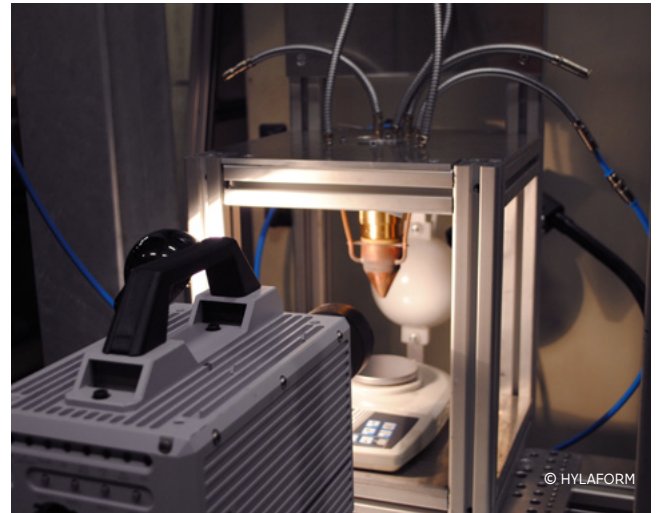
Hybrid laser-based additive
– subtractive research platform

Our state-of-the-art hybrid laser-based additive-and-subtractive research platform consists of two complementary modular research machines. In the domain of Hybrid Metal Additive Manufacturing, this infrastructure is the largest investment in Flanders to enable research on lower Technology Readiness Levels (TRLs). The infrastructure has functions that are unique in Europe. It offers a scope in

which to consolidate and strengthen the ongoing collaboration between the AM research teams at the Vrije Universiteit Brussel and KU Leuven. The platform is supported by numerous other forms of equipment and scientific research infrastructure, including software, mechanical test facilities, monitoring equipment, metrology tools, material and powder characterization equipment, etc.

HyLaForm

IN FLANDERS ACTIVE

2021

FIND US ONLINE

 avrg.vub.be

CONSORTIUM

 **Vrije Universiteit Brussel & KU Leuven**
Department of Mechanical Engineering
Pleinlaan 2, 1050 Brussel

- **Patrick Guillaume**
am.avrg@vub.be
+32 2 629 28 07
- **Brecht Van Hooreweder**
Ann.witvrouw@kuleuven.be

Activities, Equipment and Services

Our consortium offers advanced Hybrid Metal Additive Manufacturing knowledge, expertise and research facilities that support innovation and research in areas such as:

- numerical and experimental modelling of Additive Manufacturing processes;
- exploration of new materials for Hybrid Metal Additive Manufacturing;
- improvement in the precision of as-printed metal parts;
- machine design, control and monitoring solutions;
- quality control and development of structural health monitoring for AM components;
- parameter studies with static and dynamic characterization of obtained materials and Hybrid Metal Additive Manufacturing components.

Impact and Importance

Additive manufacturing offers high degrees of design freedom enabling unprecedented levels of functional integration. It makes it possible to produce personalized parts locally and efficiently. However, additive manufacturing still has some limitations. Metal printed parts typically have inferior surface roughness and it is difficult to produce fine surface textures or small internal features. The research platform enables exploration of these drawbacks. During and after the additive manufacturing of the part, corrective operations can be made through laser-beam micro-machining. As such, the research platform enables the production of high precision mechanical components that foster innovation and scientific breakthrough in multiple domains. Ultimately, the combination of additive and subtractive manufacturing will unlock even greater design freedom.



The HyLaForm research platform opens the door to high (internal and external) precision metal AM components without post-processing.

LENA CLEAN ROOM

MEMS & Packaging Clean Room

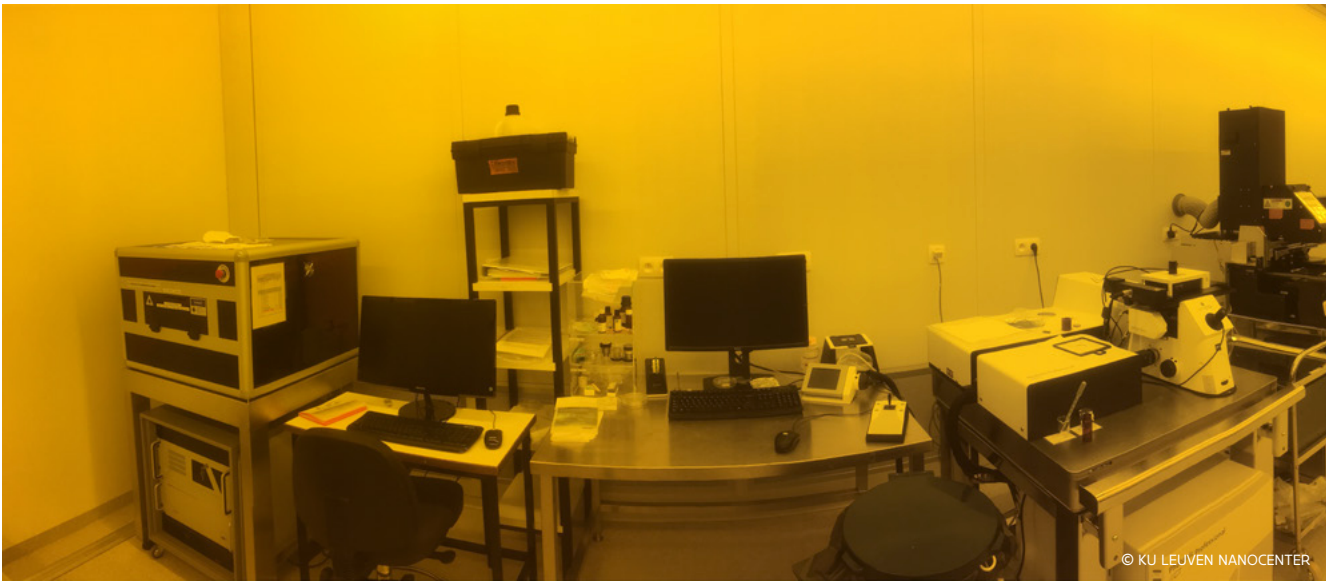

LeNa Clean Room

IN FLANDERS ACTIVE SINCE

2014

FIND US ONLINE

www.esat.kuleuven.be/micas/index.php/technology-nanocenter

USER ACCESS

www.esat.kuleuven.be/micas/index.php/technology-nanocenter

CONSORTIUM

 **KU Leuven Elektrotechniek
ESAT-MICAS**
Arenbergpark 10, 3001 Leuven

• **Michael Kraft**
Michael.Kraft@kuleuven.be
+32 16 37 37 56

The clean room (ISO class 6), a facility within the Leuven Nanocenter (LeNa), brings diverse expertise together to form a multidisciplinary research environment. It enables research into innovative concepts, such as miniaturized medical implants, flexible sensors and brain electrodes, as well as micromotors with nanoprecision components. The Hercules-sponsored equipment is inserted into an existing chain, creating a unique fabrication facility for two- and three-dimensional microstructures, combining a myriad of materials and advanced interconnections. This merge has created a highly flexible research facility, and opened the door to unique opportunities in a wide span of disciplines in science and technology, where miniaturization is of key importance.

Activities, Equipment and Services

Within LeNa, the 450m clean room houses over 35 major, state-of-the-art high-tech pieces of equipment with a cumulative value of more than 20 million EUR. The equipment includes UV, e-beam and 2Photon lithography, several vacuum deposition tools, various etchers, including DRIE, Atomic Layer Deposition, bonding and interconnecting equipment for the realization of true 3D MEMS devices. The clean room has become a highly multidisciplinary working environment used by physicists, electrical, mechanical and bioengineers, chemists, biologists and medical researchers. The field of work is very broad and includes research into new materials for MEMS devices, physical and chemical sensors, biosensors, microfluidics, lab-on-chip, electronics, brain-machine neuro-interfaces, intelligent medical implants, micro-optics and structured surfaces

Impact and Importance

Thanks to these investments and the expertise gained from using the equipment, the number of 'external' researchers in the Hercules-equipped labs has steadily increased. In 2012 we had 10% external researchers; this number has spectacularly risen to 60% in 2018. This opens new horizons, and creates novel collaborations. Since 2014, the research output directly related to the equipment has included more than 120 professional papers and more than 20 PhDs have used the tools. This has boosted the position of the Leuven Nanocenter (LeNa) in the international context. Furthermore, it has enabled the instalment of new equipment and led to ERC grants.



A unique facility that offers a wide range of expertise and equipment in a multidisciplinary atmosphere. Open to exploration, it enables processing that does not fit a standard processing line.

MC-ICP-MS

Platform for interdisciplinary isotopic research by means of multi-collector inductively coupled plasma – mass spectrometry



MC-ICP-MS

IN FLANDERS ACTIVE SINCE

2019

FIND US ONLINE

www.ams.ugent.be

USER ACCESS

www.ugent.be/sif/en

CONSORTIUM

 Ghent University
Atomic & Mass Spectrometry –
A&MS research unit
Campus Sterre, Krijgslaan 281 – S12,
9000 Gent

• Frank Vanhaecke
frank.vanhaecke@ugent.be
+32 9 264 48 48

Neptune multi-collector ICP-mass spectrometer (ThermoScientific). Multi-collector ICP-mass spectrometry (MC-ICP-MS) is a technique dedicated to high-precision isotopic analysis of metallic, metalloid, and some non-metallic elements. The precision with which isotope ratios can be measured with MC-ICP-MS (down to 0.001% relative standard deviation under ideal conditions) enables natural variations to be identified and quantified. These natural variations occur as a result of (i) the presence of longlife radionuclides in nature, affecting the isotopic composition of the element containing their daughter isotope(s); and (ii) thermodynamically and kinetically governed isotope fractionation.

Activities, Equipment and Services

Methods for isotopic analysis of a wide collection of elements are developed, optimized and validated, and subsequently used in interdisciplinary research. Relevant domains include archeometry, geo- and cosmochemistry, environmental studies and biomedical

research. Isotopic analysis can be used, for example, to date geological materials (geochronological dating), for provenance determination of the raw materials used to manufacture an archeological artefact or that resulted in 'heavy metal' contamination in a given environmental compartment, to unravel the origin and reconstruct the history of meteorites, and to obtain deeper insight into the role of essential mineral elements in human health and disease.

Impact and Importance

The A&MS unit at UGent houses two multi-collector ICP-mass spectrometers. It is the only research group housing an MC-ICP-MS in Flanders. The instrumentation is used in collaboration with researchers from UGent, KU Leuven and VUB in interdisciplinary research contexts. Access to this high-end instrumentation and class-10 clean labs for contamination-free sample pretreatment have also led to scientific collaborations with many institutions based outside Belgium.



While it is often stated that the isotopic composition of most elements is stable (invariant) in nature, all elements with 2 or more isotopes show some natural variation in their isotopic composition that can be identified when measuring with sufficiently high precision.

MULTI-NANO

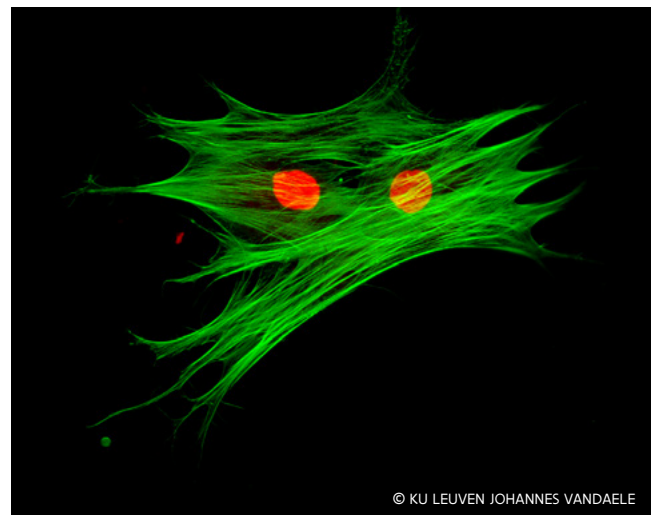
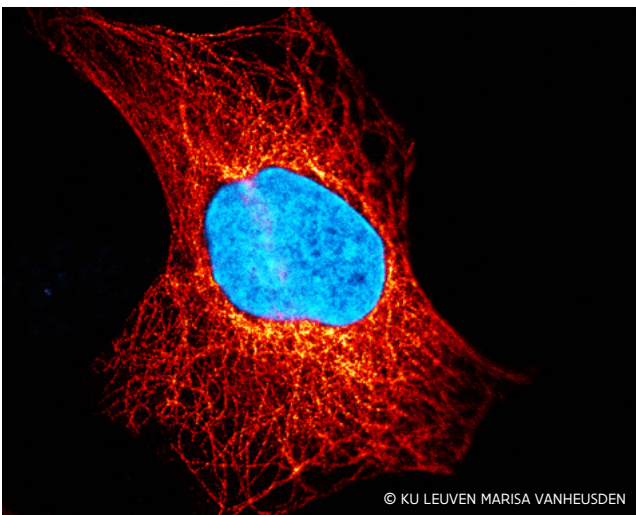
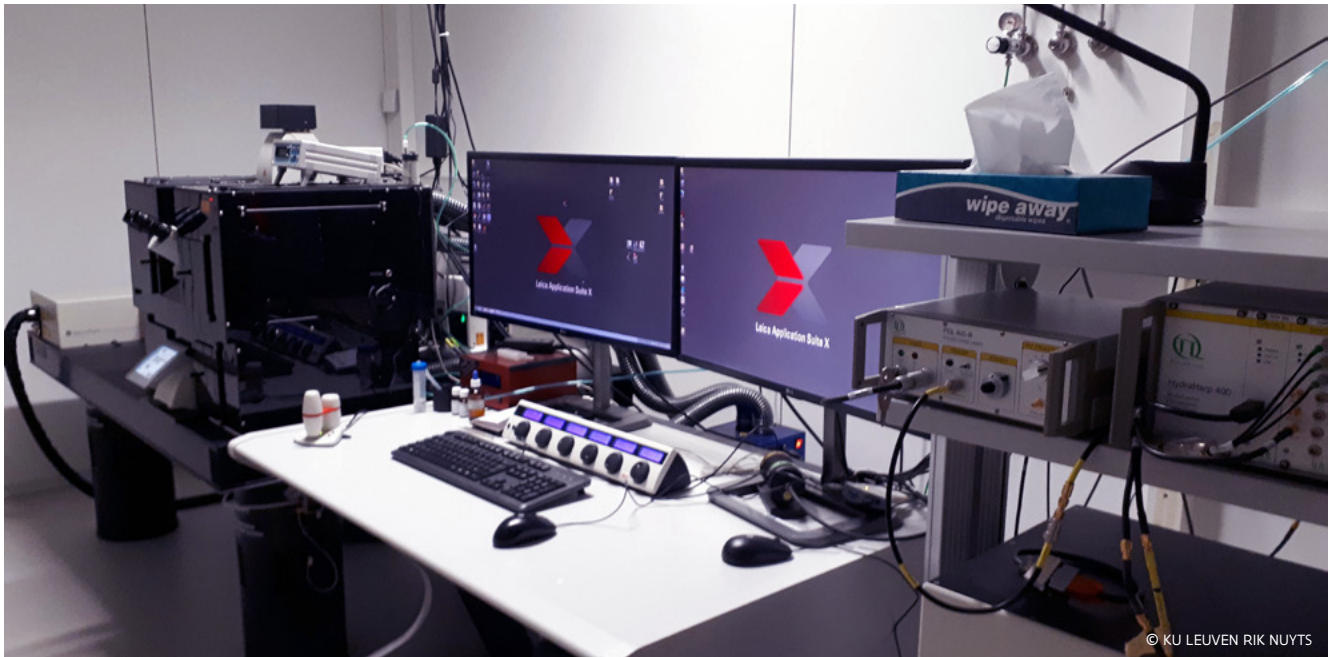
Multimodal Fluorescence Microscopy
and Nanoscopy Platform

Multi-Nano

IN FLANDERS ACTIVE SINCE

2017

FIND US ONLINE

- 🌐 www.hofkenslab.com
- 🌐 www.hofkensgroup.org

USER ACCESS

- 🌐 www.roeffaers-lab.org/media/2082/general-rules-and-user-conditions.pdf

CONSORTIUM

📍 **Katholieke Universiteit Leuven**
Molecular Imaging and Photonics
Celestijnenlaan 200f – bus 2404,
3001 Heverlee

- **Johan Hofkens**
johan.hofkens@kuleuven.be
+32 16 32 78 04

The multimodal fluorescence microscopy and nanoscopy platform offers unique capabilities for combining maximum spatial resolution, dynamic and quantitative imaging and context generation. Such a platform will enable the unravelling of new mechanisms for a wide range of applications. In addition, the robustness and ease of use guarantees these capabilities will also become accessible for non-expert users. Finally, the collaboration between the academic partners and the microscopy manufacturer Leica will result in up-to-date and state-of-the-art imaging modalities within the lifetime of the microscopy platform, as well as the generation of exploitable technology advances.

Activities, Equipment and Services

The Leica TCS SP8 features a Leica DMI8 inverted microscope with motorized stage and various objective lenses. As well as a pulsed 405nm diode laser, the setup features a supercontinuum laser that allows continuously tunable excitation in the visible range, coupled with filter-free detection. Two PMT detectors and four internal hybrid detectors are available, offering high sensitivity and superior signal-to-noise ratio. The system's tandem scanner unites the standard scanner unit with an 8kHz resonant scanner, enabling very fast acquisition. Temperature and CO₂ control are available for live-cell imaging. The system's Lambda square mapping ability allows full spectral analysis of samples and optimization of excitation and the detection range.

Included modalities are STED Nanoscopy, 2-Photon Microscopy, Digital Light Sheet and Time Correlated Single Photon Counting.

Impact and Importance

Fluorescence microscopy and nanoscopy offer the possibility of non-invasive study of structures down to the nanometric scale. Doing so dynamically will prove to be indispensable in analyzing the molecular mechanisms and organization of (non-)living systems. Technological advances in the field of microscopy have now resulted in commercially available microscopes that allow fast imaging with light levels that do not perturb or damage the system being studied, which is crucial for living systems and others. At the same time, it is necessary to be able to put this super-resolution data into the context of the larger system, requiring a combination with and integration of confocal microscopy. A platform like this will be used to unravel the answers to important research questions with societal relevance.



Nano made easy.

NMRCORE - NMR FOR CONVERGENT RESEARCH

NMR@Leuven Chem&Tech,
a Nuclear Magnetic Resonance
Spectroscopy Platform for
Convergent Research

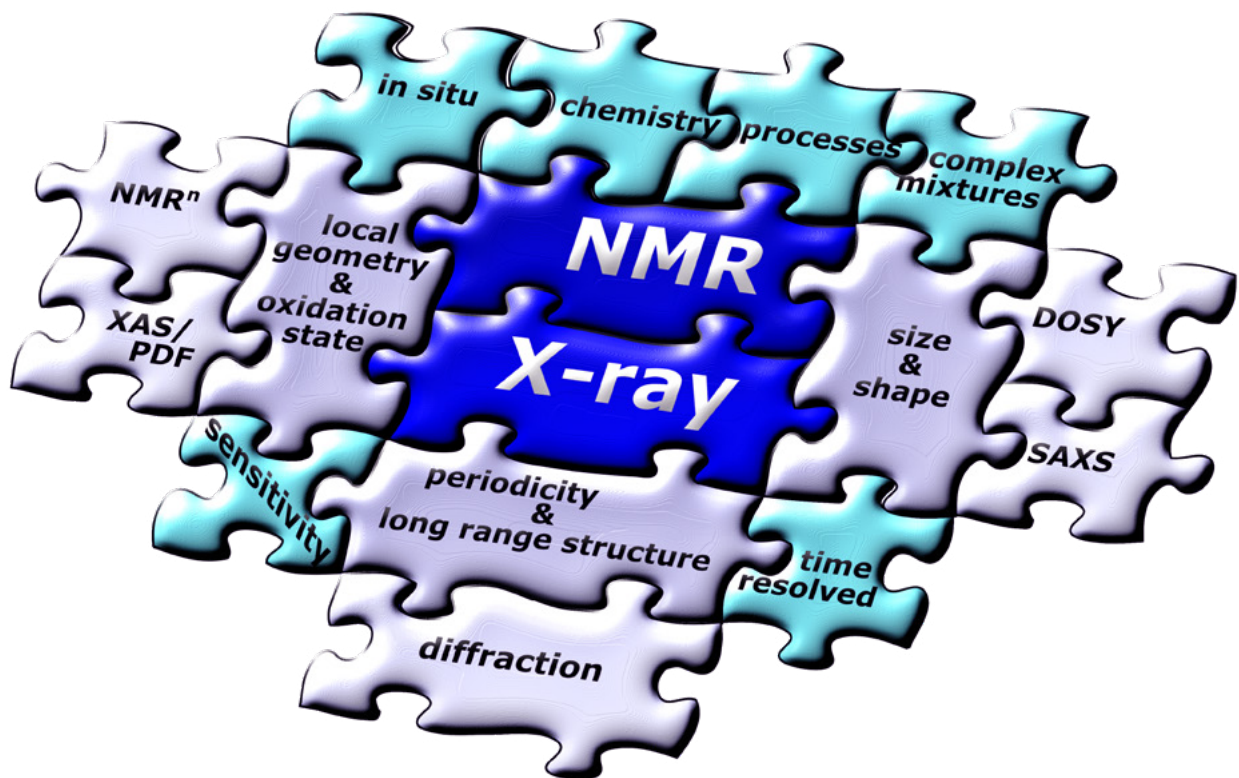

NMRCORE – NMR for CONvergent REsearch

IN FLANDERS ACTIVE SINCE

2016

FIND US ONLINE

set.kuleuven.be/nmr

USER ACCESS

set.kuleuven.be/nmr/access

CONSORTIUM

 **KU Leuven**

COK-KAT

Chem&Tech, Celestijnenlaan 200F –
box 2461, 3001 Leuven

- **Eric Breynaert**
eric.breynaert@kuleuven.be
+32 16 32 15 98
- **Johan Martens**
johan.martens@kuleuven.be

NMRCORE is a high-field solid state NMR platform. Its key focus is the description of material structure and properties on a molecular level. These investigations are performed for applications in areas including chemistry, environmental protection, sustainable energy, water, pharmaceutical formulations, environmental protection, food science and human health. The facility is designed and optimized to create an ultra-stable environment for ultra-high resolution NMR spectroscopy, with a focus on in situ investigation of porous materials and adsorbed molecules.

Activities, Equipment and Services

The facility hosts spectrometers with base frequencies of 300 up to 800 MHz. Its particular strengths are parallel acquisition, ultra-high resolution and sensitivity enhancement achieved by transferring magnetization from parahydrogen. Instrumental highlights are 500 and 800 MHz mixed state instruments, each with unique capabilities for the multi-irradiation of several nuclei. We offer a research environment dedicated to (i) advancing functional porous materials in Materials Science; (ii) development of next-generation in-situ multi-diagnostic tools focusing on sensitivity-enhanced mixed state NMR; and (iii) to provide answers to scientific challenges, regardless of application field.

Impact and Importance

NMRCORE is the only high-field solid state NMR center in Flanders. The center is part of a consortium with Bruker, a global leader in advanced NMR instrumentation, aimed at developing sensitivity-enhanced high resolution NMR for different application areas. NMRCORE is part of the Center of Molecular Water Science (DESY) and has collaborations with DUBBLE (ESRF). Synergetic development of NMR methodology with complementary characterization techniques available at large scale X-Ray facilities such as XFEL, the European X-Ray Free Electron Laser facility, the PETRA III synchrotron at DESY (Hamburg, Germany) and the European Synchrotron Radiation Facility (ESRF) (Grenoble, France) is an important asset.



Don't ask for a
spectrum, just ask a
scientific question.
Advanced NMR
can contribute more
than you
can imagine.

PARTICLE

A Proton ResearCh beam LinE for interuniversity multidisciplinary translational research

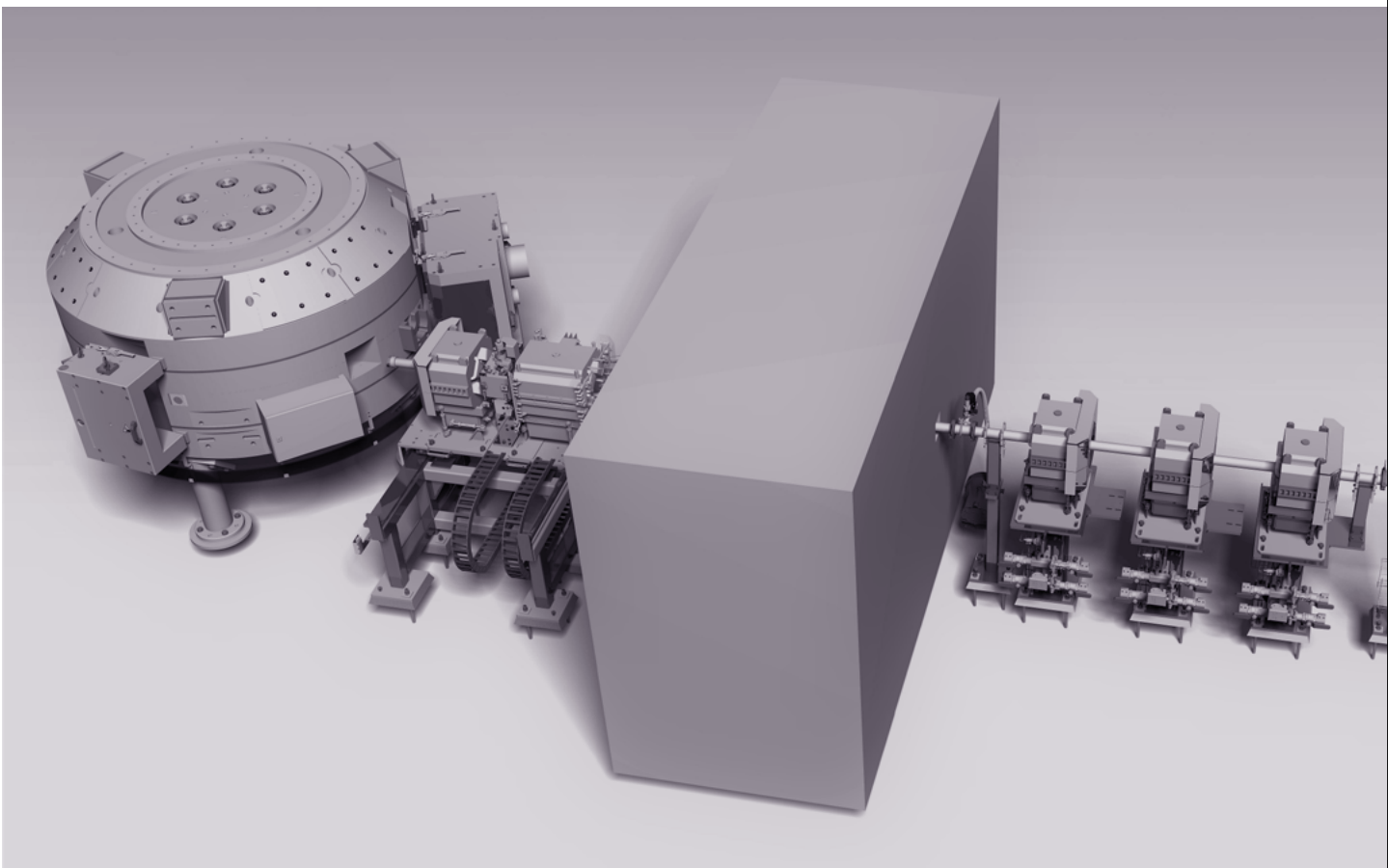

UZ Leuven and its partners are completing the construction of the first Belgian proton therapy center, called ParTICLE. Located on the Gasthuisberg Health Sciences campus of UZ Leuven, ParTICLE benefits from a unique configuration with two vaults: one for patient treatment and one dedicated to research. Each vault is equipped with its own accelerator (i.e. a superconducting synchrocyclotron) that is able to deliver proton beams

in energy levels up to 230 MeV. Having access to a separate accelerator with a fully dedicated research room offers unique advantages (e.g. no need to perform experiments after hours or on weekends to avoid interfering with the clinical workflow).

Activities, Equipment and Services

The proton research beam line consists of a modular set-up that accommodates different experiments

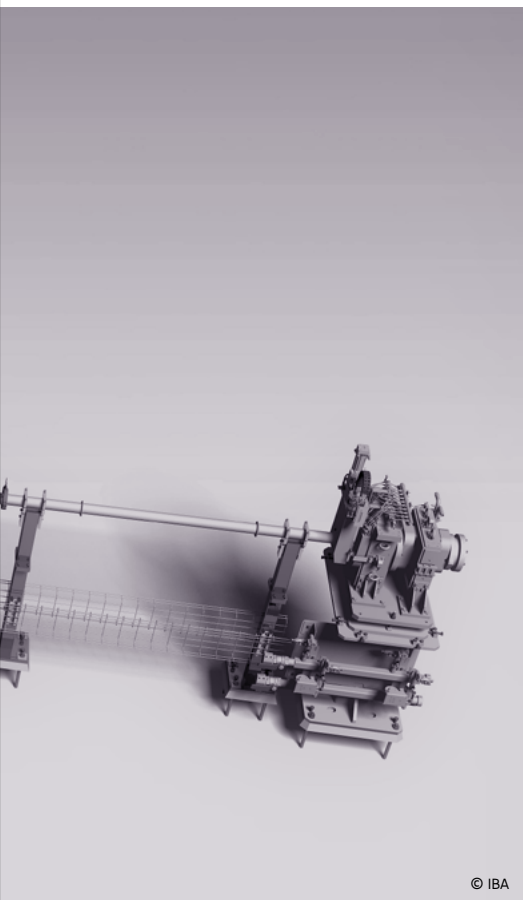

© IBA

ranging from medical physics, engineering, dose computing, radiobiology and radiation protection research, requiring either a more basic configuration or a more complex set-up. It will enable researchers to perform at near-clinical levels, as well as serving as an open interface to develop new functionalities unavailable on a proton therapy system restricted to clinical use. Hence, our proton research beam line offers unique opportunities to answer



Think like a proton, always positive!

a wide range of basic and applied research questions. The results could easily be implemented and validated in a clinical setting.

Impact and Importance

In the past few decades, radiotherapy has shifted to novel beam delivery techniques that allow dosages to be tailored to the specific tumor while limiting the impact on healthy tissue. Proton therapy can be seen as the latest technological leap within the field of radiation therapy. However, many effects of proton therapy are still to be investigated before the full potential of this new technology can be properly investigated. A dedicated beam line for experimental research purposes is of the utmost importance for performing cutting-edge proton therapy research. The research infrastructure also serves as a leverage for research collaborations with other (proton therapy) centers in Europe and beyond.

PaRtiCLE

IN FLANDERS ACTIVE SINCE

2020

FIND US ONLINE

www.uzleuven.be/en/proton-centre/research-proton-centre

USER ACCESS

Not available yet

CONSORTIUM

[UZ Leuven](#)

Laboratory of Experimental Radiotherapy

KU Leuven

Herestraat 49, 3000 Leuven

• Karin Haustermans

Karin.haustermans@kuleuven.be

+32 16 34 58 38

XCT-CENTRE

The KU Leuven X-ray Computed Tomography Centre

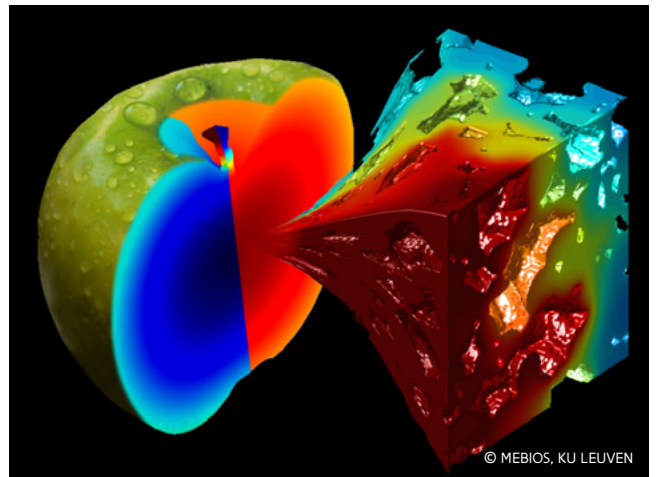
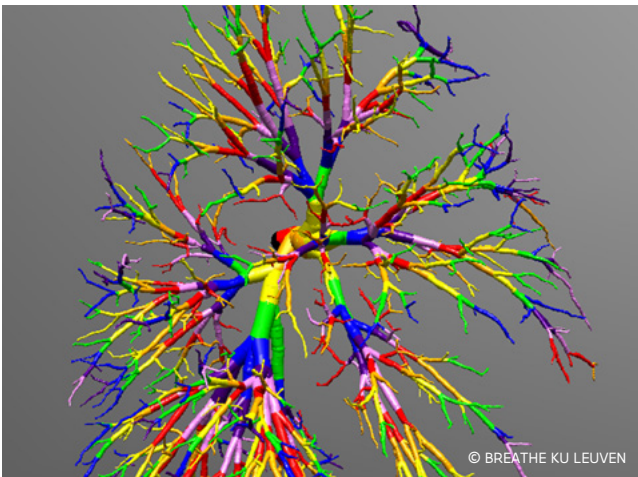
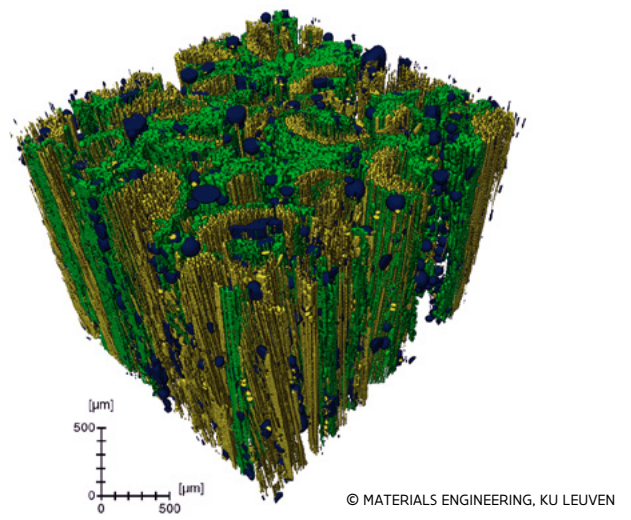
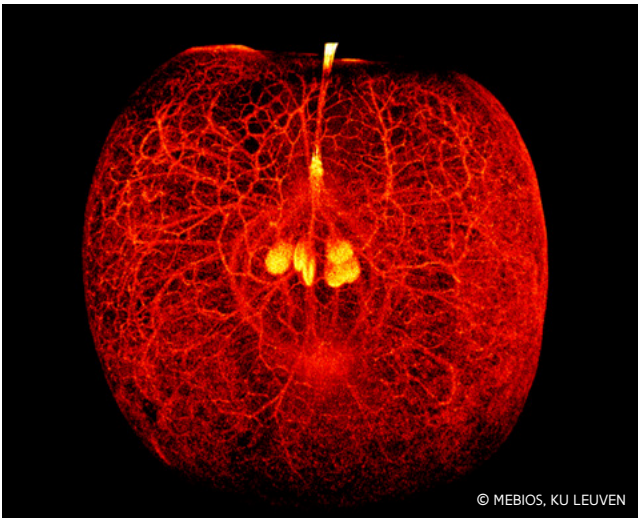

XCT-Centre

IN FLANDERS ACTIVE SINCE

2020

FIND US ONLINE

- 🌐 website under construction
- 🐦 @XCTCentre

USER ACCESS

- 🌐 not yet available

CONSORTIUM

📍 **KU Leuven**
**Materials Performance and
Non-Destructive Testing
Dpt. Materials Engineering**
Kasteelpark Arenberg 44 - bus 2450,
3001 Leuven

- **Martine Wevers**
martine.wevers@kuleuven.be
+32 16 32 13 03

The XCT-Centre currently consists of 2 microfocus XCT systems (Bruker, SkyScan 1172), 2 nanofocus XCT systems (GE, Phoenix Nanotom S and Phoenix Nanotom M) and a SkyScan μ CT attachment for scanning electron microscopes (XL30 SEM and XL30 ESEM (FEI)).

The expanded XCT-Centre will house two new microfocus systems and a new nanofocus system: TeScan Unitom XL: A dedicated 225 kV XCT scanner for in-situ 4D dynamic imaging, TeScan Unitom HR: A dedicated XCT scanner with high nanofocus resolution and Bruker SkyScan 1272: A dedicated XCT scanner with sample changer, adapted for routine scanning.

Activities, Equipment and Services

The XCT-Centre infrastructure is being expanded with new XCT devices to further research into the internal structure of materials, to unravel dynamic processes and to provide data for modelling. The possibilities offered for in-situ mechanical testing include: 4-point bending, compression, tensile testing, thermal loading and in-situ moulding (under construction). Dedicated software developed in-house and available commercial software facilitate the 3D visualization, segmentation, quantification, registration and digital volume correlation of (step-wise) datasets.

Impact and Importance

The XCT systems, with 4D-XCT possibilities, have applications suitable for use in a wide range of scientific fields, including materials research and development, civil engineering, geology, biomedical engineering, dentistry and medicine. The devices cover a resolution range of 200 nm up to 50 μ m or more. The XCT-Centre facilitates ground-breaking research aimed at unraveling the internal structure, morphology, microstructural changes or damage development in materials, products and biological specimens. It provides scientists with high quality XCT images from which quantitative data for the fundamental understanding of mechanisms and for modelling can be retrieved.



The KU Leuven
X-ray Computed
Tomography Centre:
a versatile and
structured way to
unravel material
structures and
dynamic processes.

THE LIBRARY OF VOICES

Unlocking the alamire foundation's music heritage resources collection



The Library of Voices is a high-tech audiovisual research infrastructure developed by the KU Leuven and the Alamire Foundation and integrated in St Norbert's Gate at Park Abbey. As well as a physical and digital library, the infrastructure also includes two Alamire Sound Labs. Of these, the Analytic Lab features an interactive touchscreen, a digital Timax auralisation processor, and a 20-loudspeaker setup, that makes it possible to position up to 64 individual voices simultaneously

around the room. The other sound lab, the Interactive Lab, features a high-resolution digital music stand, 6 microphones, an Astro auralisation processor for ambisonics, a three-dimensional setup of 28 loudspeakers, and the ability to add virtual acoustics in real-time. Six Ottocanali multichannel amplifiers power the Sound Labs.

Library of Voices

IN FLANDERS ACTIVE SINCE

2018

FIND US ONLINE

www.alamirefoundation.org/en/centre-of-excellence/library-of-voices

USER ACCESS

www.alamirefoundation.org/en/centre-of-excellence/library-of-voices

CONSORTIUM

 **KU Leuven (Musicology, ESAT)
& Alamire Foundation**
Blijde Inkomststraat 21, 3000 Leuven

- **David Burn**
david.burn@kuleuven.be
+32 16 32 48 87
- **Toon Van Waterschoot**
- **Bart Demuyt**



It is impressive how this state-of-the-art audio technology is seamlessly integrated into a heritage site, and how it provides an innovative tool for researching this intangible subject matter, the musical heritage of the low countries.

Activities, Equipment and Services

This high-tech, innovative and interdisciplinary platform enables Alamire Foundation to implement digital images, to further develop their unique collection with the Alamire Digital Lab (ADL), to digitally distribute the collection through the Integrated Database for Early Music (IDEM) and valorise it in sound and image with the state-of-the-art polyphonic Alamire Sound Labs for data analysis and data exploitation, with the use of advanced auralisation techniques. The Library of Voices is a unique tool for researching the layered nature of polyphony, where a musical source can be studied using the latest technology, analysed audiovisually, and where—in a completely new approach—it is possible to reconstruct and study the acoustic circumstances in which the composition was created centuries ago.

Impact and Importance

The Library of Voices represents both a broadening and a deepening of the activities the Alamire Foundation/the Musicology Research Unit performs with their partners: the Department of Electrical Engineering ESAT KU Leuven and LIBIS, a division of Leuven Research and Development. The research infrastructure presents innovations that exist nowhere else in the world. For example, an innovative research instrument will be instrumental for the Alamire Foundation in becoming the global epicentre for practice-based research into the vocal music of the Middle Ages and the Renaissance.

DEPARTMENT OF
ECONOMY
SCIENCE &
INNOVATION

fwo